



Rev 04/03/24

This page intentionally left blank

Table of Contents

1.	Introduction.....	5
2.	Warranty.....	5
3.	Filter Bags	5
4.	Contact Information	5
5.	Method Comparison (Manual vs. Automated).....	6
6.	Instrument Description.....	7
7.	Operating Environment	10
8.	Safety Precautions	10
9.	Instrument Installation	11
10.	Dietary Fiber Analysis Support Items.....	17
11.	Analysis Options using the ANKOM ^{TDF} Dietary Fiber Analyzer	17
12.	Blanks.....	17
13.	IDF/SDF Analysis (AOAC 991.43).....	18
14.	TDF Analysis (AOAC 991.43)	35
15.	TDF Analysis (AOAC 985.29 / 2001.03)	51
16.	Protein Determination.....	66
17.	Ash Determination.....	68
18.	Productivity Enhancement	70
19.	Status Screen	74
20.	Fault Handling.....	78
21.	Diagnostics Mode	80
22.	Periodic Maintenance.....	88
23.	Troubleshooting & Replacement Parts.....	89
24.	Volume Calibration Procedure	90
25.	Temperature Sensing.....	94
26.	Appendix A – Reagents (AOAC 991.43, 985.29, 2001.03)	96
27.	Appendix B – Analytical Procedures	98
28.	Appendix C – Line Flushing Procedure.....	102
29.	Appendix D – Accessories (sold separately)	104

This page intentionally left blank

1. Introduction

ANKOM Technology designs, manufactures, and markets instruments and support products used by analytical laboratories around the world in the food, feed, bio-energy, agricultural, and environmental industries. ANKOM Technology can provide you with products for determining or monitoring dietary fiber, detergent fiber, crude fiber, fat, digestibility, microbial fermentation (anaerobic or aerobic) and more.

Committed to Total Customer Satisfaction, ANKOM designs every product based on a thorough assessment of customer needs.

Congratulations on your purchase of the ANKOM^{TDF} Dietary Fiber Analyzer. We are confident that this product will effectively serve your needs.

The ANKOM^{TDF} Dietary Fiber Analyzer was designed to eliminate most of the manual steps required by the method. This reduces technician variation, increasing precision. By carefully following the operating instructions in this manual you will understand the details of sample and filter bag handling as well as instrument control, helping you to achieve the best possible results.

NOTE: Please review the entire manual before you begin operating this product.

2. Warranty

ANKOM Technology warrants the ANKOM^{TDF} Dietary Fiber Analyzer against any defects in workmanship or material for one year after the original date of purchase. This warranty does not include damage to the instrument resulting from neglect or misuse. During the warranty period, should any failure result from defects in workmanship or materials, ANKOM Technology will, at its discretion, repair or replace the instrument free of charge.

Extended warranties are available upon request.

3. Filter Bags

Use ANKOM Technology filter bags (part #'s DF-I, DF-S, DF-FT) in your ANKOM^{TDF} Dietary Fiber Analyzer. Filter bags can be purchased from ANKOM Technology or from your local authorized ANKOM distributor.

4. Contact Information

Committed to your total satisfaction, we are always available to help you get the most from your ANKOM products and to receive any comments or suggestions you might have to help us improve.

For any questions or suggestions regarding your instrument, please contact us:

For Sales Support: sales@ankom.com or <https://www.ankom.com/contact-us>

For Technical Support: www.ankom.com/contact/technical-services

For Analytical Support: www.ankom.com/contact/analytical-services

Telephone: (315) 986-8090

Fax: (315) 986-8091

5. Method Comparison (Manual vs. Automated)

AOAC 991.43 Method – IDF/SDF assay without automation

Below is the AOAC 991.43 method flow done manually by a technician using glass crucibles and beakers, vacuum to assist with filtering, and water baths to control temperature and mixing. DE refers to Diatomaceous Earth.

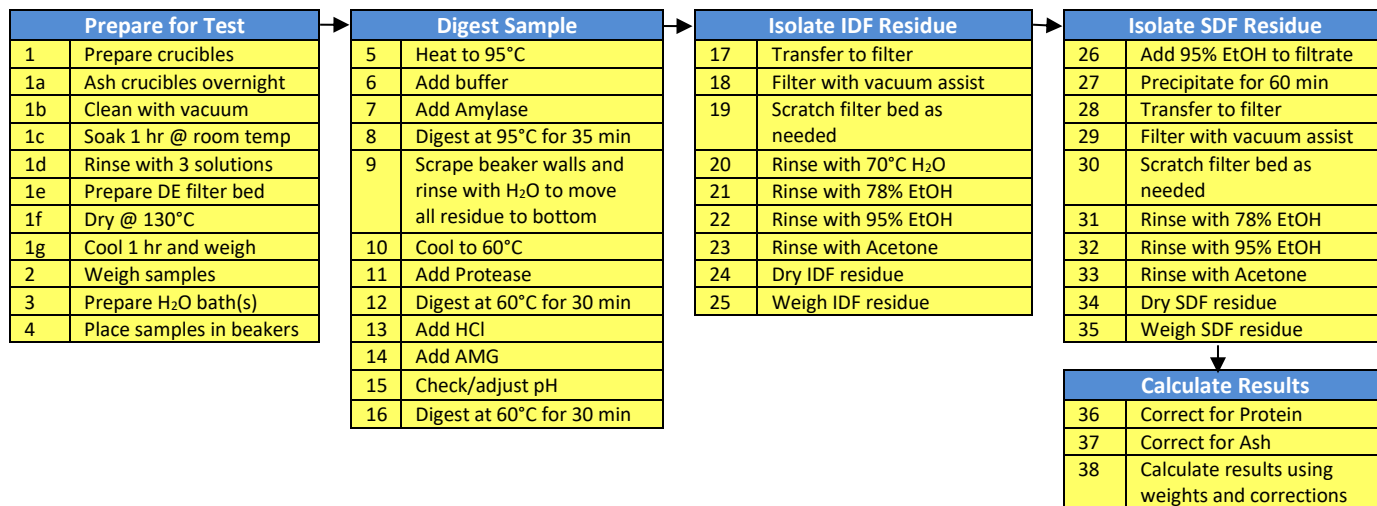

AOAC 991.43 Method – IDF/SDF assay with ANKOM^{TDF} Dietary Fiber Analyzer automation

Below is the AOAC 991.43 method flow when using the ANKOM^{TDF} Dietary Fiber Analyzer. Steps highlighted in YELLOW represent tasks done by a technician. Steps highlighted in GREEN (1a-1g, 9, 19, and 30) are no longer needed because of Filter Bag Technology. All other steps (including mixing) are done automatically by the ANKOM^{TDF} Dietary Fiber Analyzer under computer control. DE refers to Diatomaceous Earth.

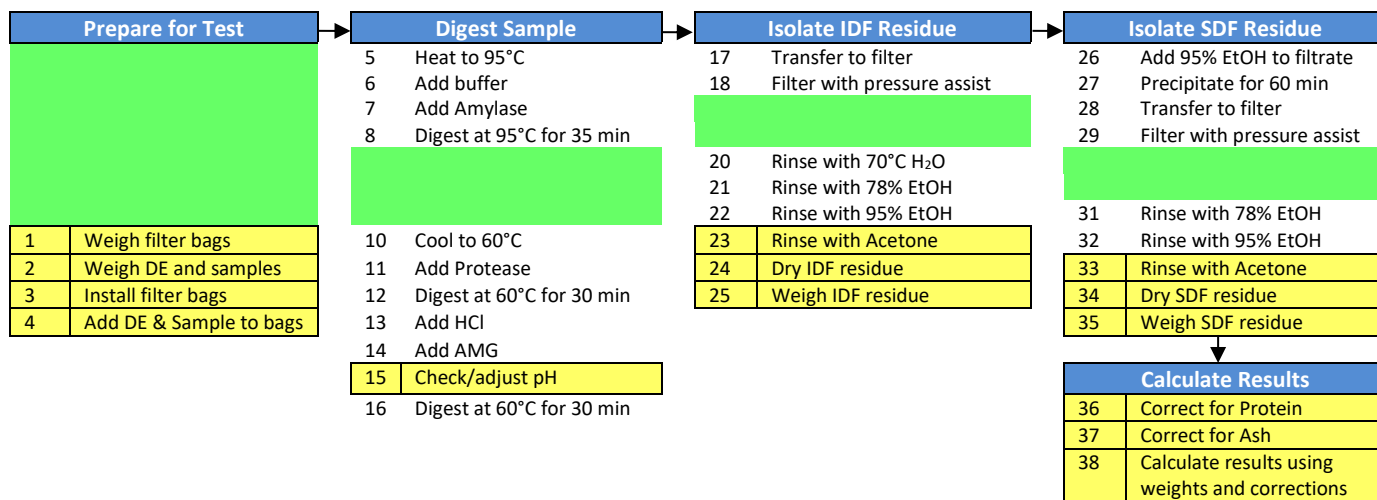

NOTE:

This section is just an overview of how the ANKOM^{TDF} Dietary Fiber Analyzer executes the AOAC 991.43 method. Please see the "IDF/SDF Analysis" and "TDF Analysis" sections of this manual for detailed instructions on how to perform IDF/SDF and TDF assays with the analyzer.

6. Instrument Description

The ANKOM^{TDF} Dietary Fiber Analyzer is designed to efficiently, accurately, and precisely recover Insoluble Dietary Fiber (IDF), Soluble Dietary Fiber (SDF), and Total Dietary Fiber (TDF) residue from food and/or feed samples in accordance with the AOAC 991.43, AOAC 985.29, AOAC 2001.03, AACC 32-07.01, and NMKL 129, 2003 methods.

NOTE: Contact ANKOM Technology about an upgrade to Total Integrated Dietary Fiber (AOAC 2009.01, 2011.25 and 2017.16 methods). See the Diagnostics section of this document for instructions on how to enable these methods.

Enabled by Filter Bag Technology, the instrument can run six digestion and six precipitation processes at the same time. The filter bags are designed to capture the appropriate fiber particles while allowing all non-fiber components to pass through. The instrument will use IDF bags and SDF bags when configured to recover IDF and SDF residue. The instrument will use IDF *Flow-Thru* bags and SDF bags when configured to recover TDF residue.

The automated fiber recovery is achieved by first digesting samples within bags using enzyme treatments. Depending on the filter bag configuration, the instrument then collects the IDF and SDF residue using two separate filters, or collects the TDF residue using one filter. Once captured in the filters the residue is dried, weighed, and corrected for protein and ash content to determine the IDF, SDF, and/or TDF values.

Digestion, precipitation, rinse (H₂O and EtOH), and filter operations are performed by the instrument, eliminating manual transfer and filtration steps. An on-board computer precisely controls process temperatures, agitation, and fluid delivery along with digestion, precipitation, and filtration times.

6.1. External Components – Front View

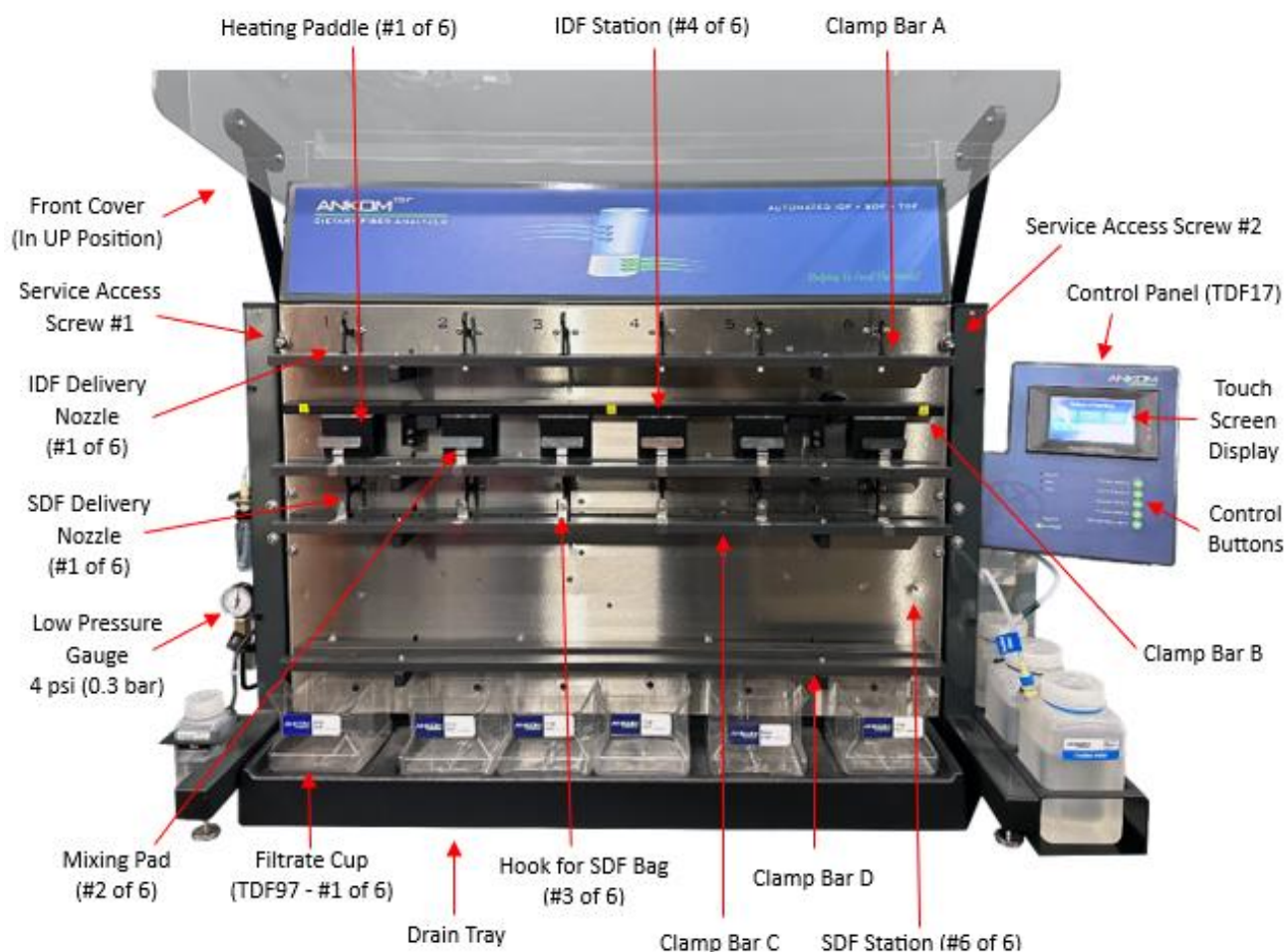

6.2. External Components – Left Side View

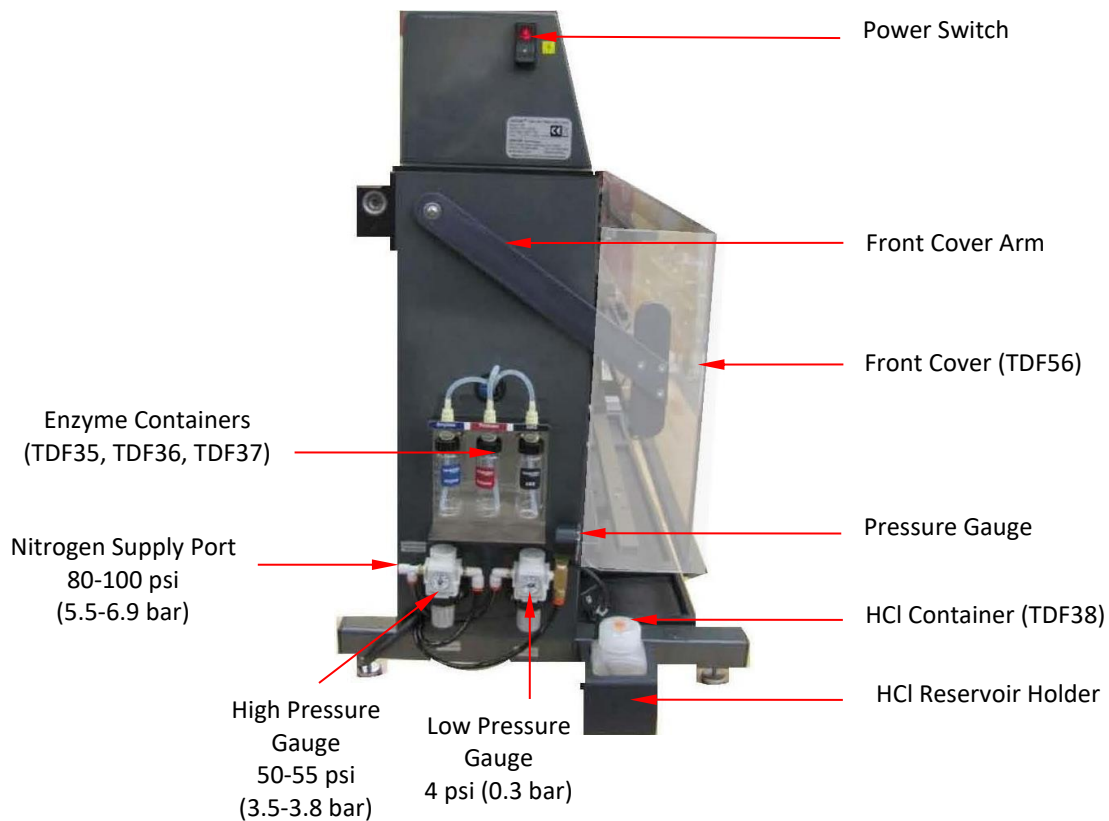

6.3. External Components – Right Side View

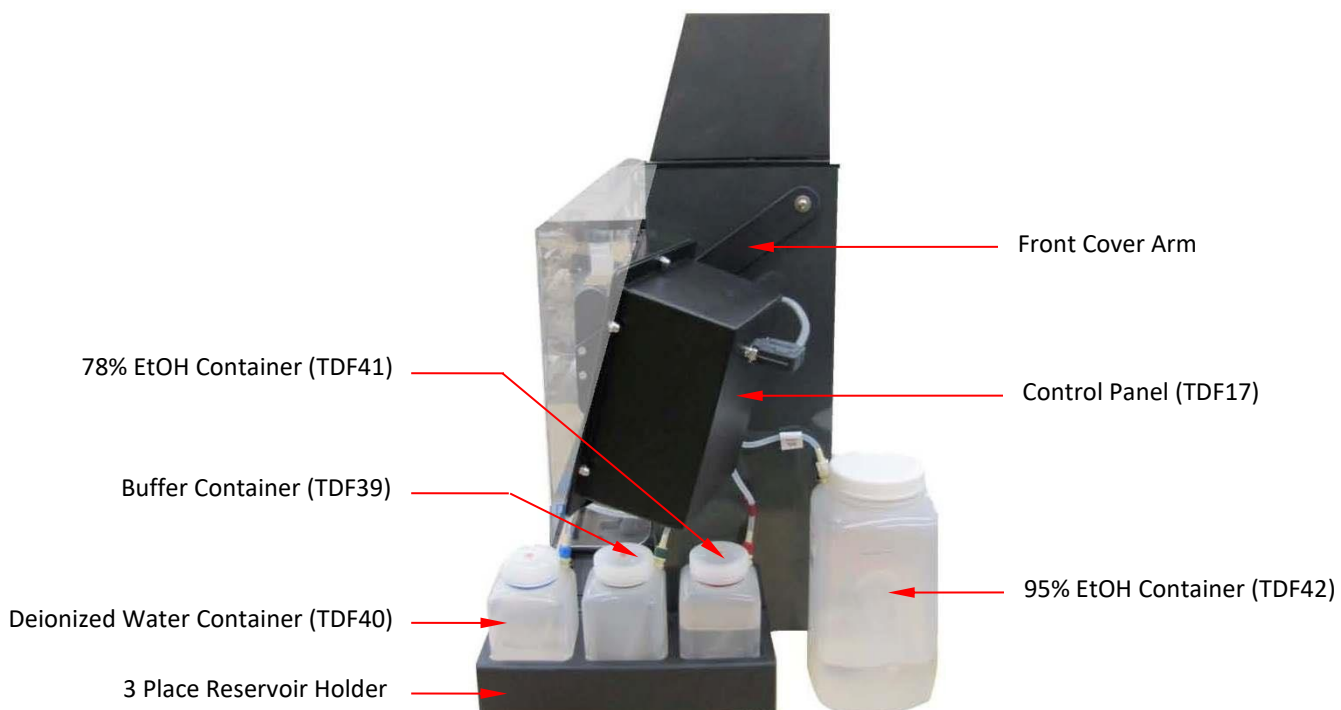

6.4. Internal Components – Rear View

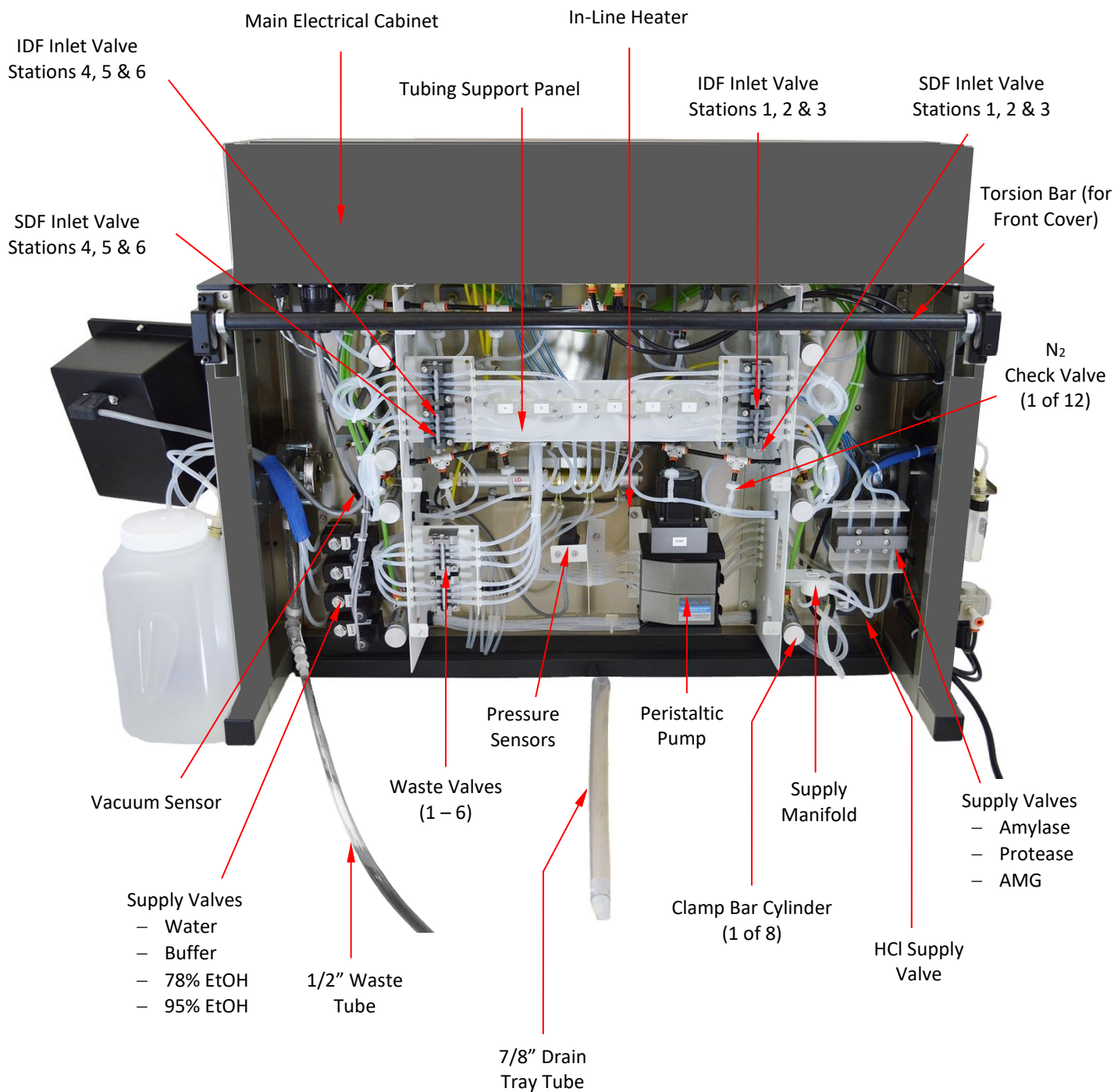

6.5. Service Access Position

If your instrument must be located in such a way as to restrict access to the back, you can tilt it forward to access the rear of the instrument by removing the two Service Access Screws on the front of the instrument and gently pulling the top of the Main Electrical Cabinet forward and down. The instrument will pivot at its center.



7. Operating Environment

Your ANKOM^{TDF} Dietary Fiber Analyzer is designed to operate within the following environments:

- Ambient Temperature Range: 19°–30°C
- Humidity: 20–60% RH
- Power: 100V–120V ~ 50/60Hz 15A
220V–240V ~ 50/60Hz 8A

8. Safety Precautions



Hot Surfaces – Do NOT touch the Heating Paddle surfaces during operation. The surface can exceed 100°C (212°F). **Failure to observe this caution may result in burns.**

Hazardous Voltages – Do NOT operate the instrument with the back of the Main Electrical Cabinet removed. Hazardous voltages are present during operation.

Failure to observe this caution may result in electrical shock or electrocution.

Hazardous Materials – Ethanol is used within this instrument. Follow both local and federal regulations for vent hood requirements when operating this instrument. Do NOT heat seal or place filter bags in an oven until all acetone has evaporated. **Failure to observe this caution may be hazardous to your health.**

WARNING: Attempts to override safety features or to use this instrument in a manner not specified by ANKOM Technology voids the warranty and may result in serious injury or even death.

This system is designed to meet and/or exceed the applicable standards of CE and CSA.

IMPORTANT:

The Power Switch must be in the OFF position before plugging the instrument Power Cord into the power source.

NOTE:

Please review the entire manual before you begin operating this instrument.

9. Instrument Installation

9.1. Site Requirements

To install and operate the ANKOM^{TDF} Dietary Fiber Analyzer you will need the following:

- Adequate power (see "Operating Environment" section of this manual)
- Drain or waste container to capture waste fluids
- Bench space that can accommodate the instrument dimensions of 132 cm (52") L x 92 cm (35") H x 77 cm (30") D
- Adequate compressed nitrogen supply/tank with regulator that reduces nitrogen supply to 80-100 psi (5.5-6.9 bar)
- Fitting adapter to connect nitrogen supply to the 1/4" (6.35mm) outside diameter, ANKOM supplies the black nitrogen supply tubing

IMPORTANT: Do NOT run this instrument without an adequate dry Nitrogen Supply. The instrument is powered by pneumatics that are not compatible with moisture, commonly found in compressed air. Nitrogen is also recommended as an extra precaution when handling ethanol. For these reasons compressed air is NOT recommended. You can run approximately 6-7 full runs (IDF/SDF or TDF) with a 304 cu ft tank of nitrogen.

9.2. Unpack and place the instrument where it will be used.

The instrument shipping container consists of three separate cardboard pieces: a top, a bottom, and a sleeve that forms the body of the container. Remove the top and the sleeve of the instrument shipping container. Lift the instrument off of the shipping container bottom and place it on a surface that is firm and level in an area near a Nitrogen Supply and a drain or chemical waste container.









NOTE: Waste fluids are drained from the instrument using gravity. Therefore, position the instrument so that both the 1/2" waste tube and the 7/8" drain tray tube run down into a waste container.















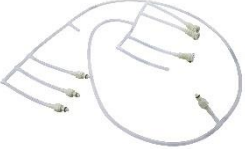



The instrument must not be subjected to excessive shock, vibration, dirt, moisture, oil, or other fluids.

IMPORTANT: Ethanol is used within this instrument. Follow both local and federal regulations for vent hood requirements when installing this instrument.

9.3. Unpack the attachments and accessories.

Within the shipping container is a cardboard box containing attachments and accessories. Open the box and verify that all of the following items are there.

<p>1 – Crescent Wrench (204.9)</p> 	<p>1 – 1/8" Allen Wrench (Z303)</p> 	<p>1 – Wrench for Burkert Valves (Z279)</p> 
<p>1 – 3/8" Nut Driver (8416)</p> 	<p>1 – 3/8" wrench (8418)</p> 	<p>2 – Spray Tips (TDF44)</p> 
<p>1 – Spray Tip Cleaning Tool Kit (TDF94)</p> 	<p>1 – Bag Weigh Holder assy (TDF52)</p> 	<p>1 – Drying Rack assy (TDF50)</p> 

<p>1 – Drain Tray (8002)</p> 	<p>1 – Black Nitrogen Supply Tubing (8216)</p> 	<p>1 – USB with Calculation & Volume Calibration Templates</p> 
<p>1 – Pinch Valve Tubing Set (TDF71)</p> 	<p>1 – Long Life Pump Tube Set (TDF99)</p> 	<p>1 - Line Flush Tubing Assy (TDF70)</p> 
<p>1 – Amylase Container Assy (TDF35)</p> 	<p>1 – Protease Container Assy (TDF36)</p> 	<p>1 – AMG Container Assy (TDF37)</p> 
<p>1 – HCl Container Assy (TDF38)</p> 	<p>1 – Mes-Tris Buffer Container Assy (TDF39)</p> 	<p>1 – Deionized Water Container Assy (TDF40)</p> 
<p>1 – 78% EtOH Container Assy (TDF41)</p> 	<p>1 – 95% EtOH Container Assy (TDF42)</p> 	<p>6 – Filtrate Cups (TDF97)</p> 
<p>1 – Control Panel Assy (TDF17)</p> 	<p>1 – Drain Hose Assembly (TDF96) that includes these five parts</p> <p>1 - Adhesive Clamp (8133)</p> <p>1 – Drain Tube (8132)</p> 	
<p>2 – Desiccant Pouches (X45)</p> 	<p>1 – Drain Tube Clamp (6138)</p> 	<p>2 – Drain Tube Elbow Connectors (8288)</p> 

<p>1 – 3 Place Reservoir Holder (8191)</p> 	<p>1 – HCl Reservoir Holder (8192)</p> 	<p>4 – Bolts (5626) 4 – Nuts with star washers (167) 4 – Acorn Nuts (8409)</p> 
<p>12 – TDF Calibration Cup Set (TDF128)</p> 	<p>1-Fuse (206)</p> 	
<p>2 – Container Filters (8202)</p> 	<p>1 – Buffer Filter (8203)</p> 	
<p>1 – Lighted Magnifier (TDF45)</p> 	<p>2 – Fuses (8305-15A or 8306-8A)</p> 	

NOTE: Accessories specific to the 2009.11 & 2011.25 method upgrades can be found in the "Automated AOAC 2009.01/2011.25 and AACC 32-45.01 method" addendum.

9.4. Place the Drain Tray under the front of the instrument.

There are 4 adjustable feet at the bottom of the right and left support legs on your TDF instrument. These need to be extended to accommodate the height of the drain tray that slides under the instrument. Extend to 1" (25mm) height each of the feet as shown below. Tighten the Lock Nut to the underside of the leg to lock the foot into position.

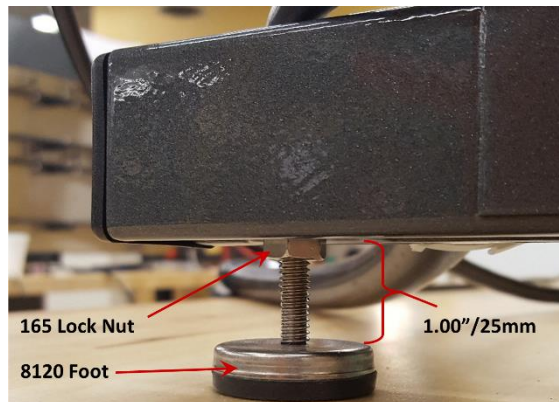

With the Drain Tube connector pointing away from you, slide the tray under the front of the instrument until it cannot go back any farther. (When the tray is in place, the side ridges will contact the front face of the steel frame.)

9.5. Place the six Filtrate Cups on the Drain Tray.

If filtrate collection is required for further analysis, leave the red plug in the lower port near the bottom of each of the filtrate cups. If filtrate collection is not needed, keep the filtrate cups in place on the drain tray, however, the red plug can be pulled from the lower port to allow the filtrate to drain into the drain tray. Store the plug in a safe place for future use if necessary.

9.6. Connect the Drain Tube to the Drain Tray.

The ½" Waste Tube comes pre-installed. Connect and secure the 7/8" Drain Tube to the Drain Tray using the supplied Drain Tube Clamp. Run the waste tube and drain tray tube to either a drain or waste container. Avoid twists in the tube. If necessary, cut the Drain Tube and use the Elbow Connectors to meet the needs of your location.

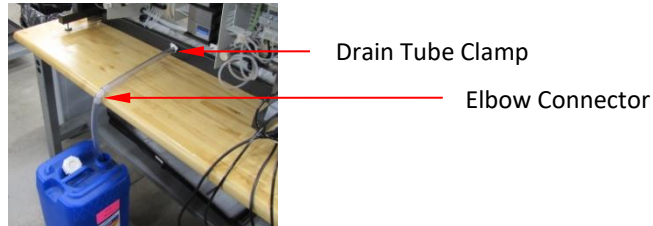

As needed, place the Adhesive Clamp (8133) between the Drain Tube Clamp and the Elbow Connector to create the appropriate tube slope for good fluid flow.

9.7. Connect the Chemical Container Holders to the feet of the instrument.

Remove the nuts from the outside of the left and right feet of the instrument. Slide the HCl Reservoir Holder onto the PEM studs on the left foot and the 3 Place Reservoir Holder onto the PEM studs on the right foot. Secure the holders using the nuts.

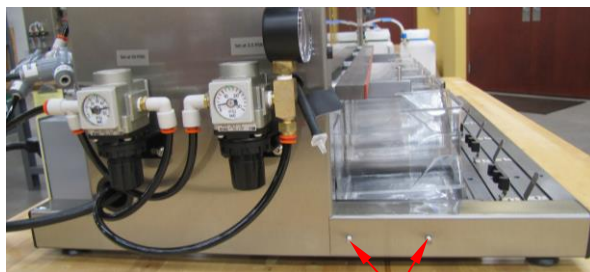

PEM studs to attach the HCl Reservoir holder

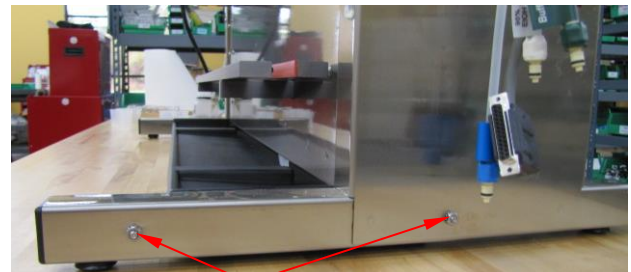

PEM studs to attach the 3 Place Reservoir Holder

9.8. Connect the Control Panel to the instrument.

Remove the lock nuts from the right side of the instrument. Slide the Control Panel onto the PEM studs and secure it in place using the lock nuts. Connect the 25-pin connector from the instrument to the Control Panel.

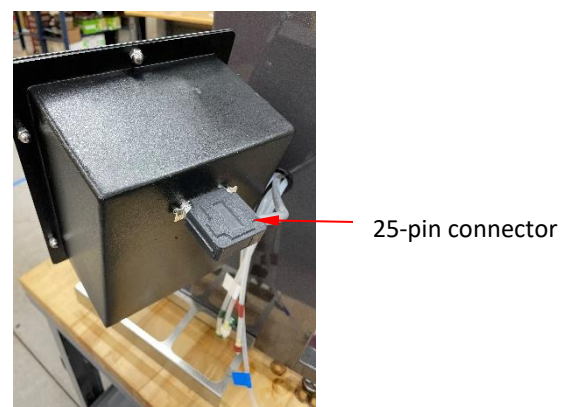
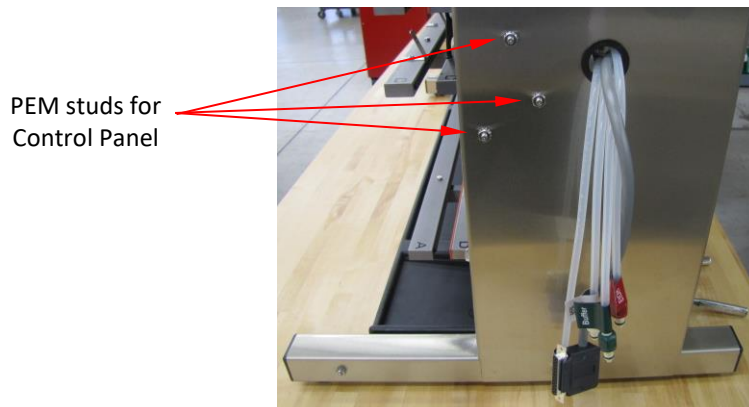

9.9. Place the Chemical Containers in their holders.

NOTE: If you are going to run an IDF/SDF or TDF analysis immediately after installing the instrument, fill the Chemical Containers above the Minimum Level lines and fill the Enzyme Containers with at least 15 ml of solution before connecting the containers to the instrument. See Appendix A for the chemical preparations. Do NOT fill the Chemical and Enzyme Containers if the instrument is going to sit unused after installation.

Place the HCl Container in the HCl Reservoir Holder on the left side of the instrument. In the 3 Place Reservoir Holder on the right side of the instrument, place the Deionized Water Container in the front section, the Buffer Container in the middle section, and the 78% EtOH Container in the back section. The 95% EtOH Container sits on the bench behind the container holder.

IMPORTANT: To ensure proper fluid delivery, you must use the Chemical Containers provided with the instrument and place them in their specified locations.

9.10. Connect the Chemical Containers to the corresponding tubes.

The Chemical Containers and associated tubes are all labeled and color-coded for easy connection. The large containers on the right side of the instrument also have push-on connectors. **Make sure that you hear a click sound when you connect the tubes to the containers.**

On the left side of the instrument is a black tube with an HCl label that has a white barbed fitting on its end. Push the white barbed fitting into the black tube connected to the HCl container.

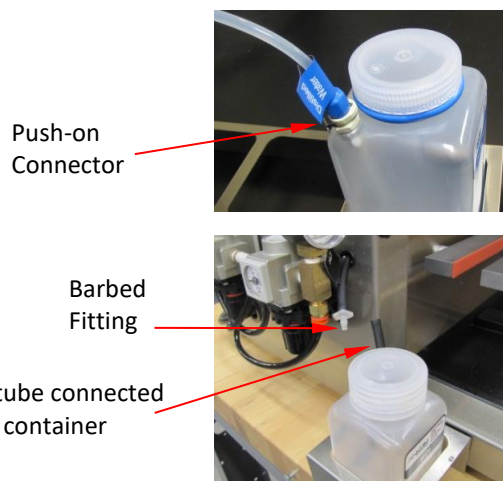

9.11. Connect the Enzyme Containers to the corresponding ports.

The Enzyme Containers connect into labeled, color-coded ports on the left side of the instrument using push-on connectors. **Make sure that you hear a click sound when you connect the enzyme containers to the ports.**

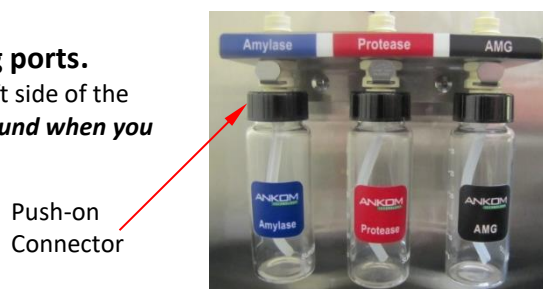

9.12. Connect the Nitrogen Supply to the Nitrogen Supply Port.

Connect the Black Nitrogen Supply Tube (8216) that came with the instrument to the Nitrogen Supply Port on the instrument and to the Nitrogen Supply.

IMPORTANT: ANKOM highly recommends using Nitrogen for the pressurized gas in the TDF instrument. The multiple valves in the instrument are sensitive to moisture which is often found in Compressed Air systems. Using Compressed Air instead of Nitrogen will likely reduce the life of these components. Inert Nitrogen also reduces any potential flammable hazard when handling EtOH.

Nitrogen Supply Port
80-100 psi
(5.5-6.9 bar)

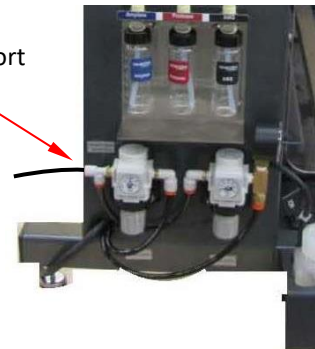

NOTE: If you want to use a separate tube to connect your instrument to a Nitrogen Supply, the Nitrogen Supply Port has a Push-to-Connect fitting that accepts 1/4" OD tubing. Acceptable tubing materials include Nylon, Polyurethane, Polyolefin, and Polytetrafluoroethylene (PTFE). The tubing material must be suitable for the specified pressure.

9.13. Verify that the High and Low Pressure Regulators are set properly.

Verify that the High Pressure Regulator is set to 50-55 psi (3.5-3.8 bar), and the Low Pressure Regulator is set to 4 psi (0.3 bar).

High Pressure Regulator
50-55 psi
(3.5-3.8 bar)

Low Pressure Regulator
4 psi
(0.3 bar)

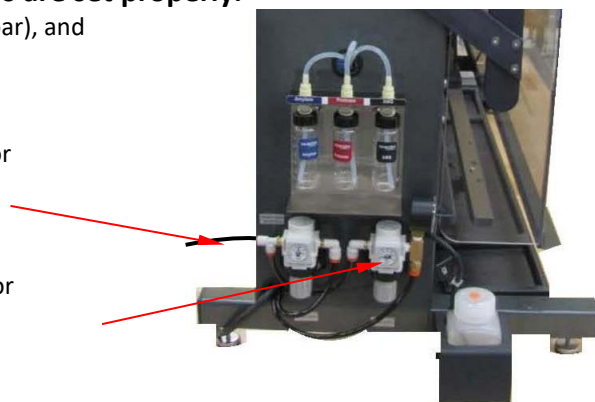

9.14. Volume Calibrate the Instrument

A Volume Calibration should be performed upon initial setup and once a week for the first month of use. After the first month, perform a volume calibration once a month thereafter and immediately after installing new pump tubes. It is important that the instrument is calibrated to verify that it is delivering the correct amount of fluid through the pump. Refer to the Volume Calibration Procedure section in the manual.

10. Dietary Fiber Analysis Support Items

The following support items needed to perform the fiber analysis may be purchased separately:

Item	ANKOM Part #
Heat Sealer for sealing the filter bags	HS (120V), HSi (220V)
IDF Filter Bags	DF-I
SDF Filter Bags (used for SDF and TDF procedures)	DF-S
IDF <i>Flow-Thru</i> Bags (TDF procedure only)	DF-FT
Solvent Resistant Marker	F06
Rinse Stand	TDF51
Diatomaceous Earth (DE)	DE1, DE2
Drying Oven	
Electronic Balance with four-place readout	
Ashing Oven	
Protein Determination Equipment (Kjeldahl is recommended)	

11. Analysis Options using the ANKOM^{TDF} Dietary Fiber Analyzer

The ANKOM^{TDF} Dietary Fiber Analyzer can be configured to recover IDF and SDF residue, or to recover TDF residue. The following describes these analyses along with their specific filter bag configurations.

Analysis Name	Analysis Description	Upper Bag	Lower Bag
IDF/SDF (991.43)	This analysis is used to determine IDF and SDF residue separately using two different filter bags. TDF is calculated by adding the IDF and SDF residue weights corrected for protein and ash content.	IDF	SDF
TDF (991.43, 985.29 & 2001.03)	This analysis is used to determine TDF residue in one filter. In this analysis, the TDF value consists of the weighed residue corrected for protein and ash.	IDF <i>Flow-Thru</i> (no filter)	SDF

A computer-controlled Diagnostics mode is provided through the Control Panel for maintenance and troubleshooting purposes. To maximize productivity, this instrument also allows a user to start new procedures (IDF/SDF and TDF) before the previous ones have completed. See the "Productivity Enhancement" section of this manual for details.

NOTE:	Contact ANKOM about an upgrade to Total Integrated Dietary Fiber (AOAC 2009.01, 2011.25, and 2017.16 methods). See the Diagnostics section of this document for instructions on how to enable these methods.
--------------	--

12. Blanks

BLANK values are used in the IDF, SDF, and TDF calculations. The following BLANK values (based on extensive research done in the ANKOM lab) are the default values loaded in the IDF_SDF and TDF spreadsheets in the MS-Excel workbook provided with the instrument.

IDF (AOAC 991.43 method):	-0.0072	TDF (AOAC 991.43 method):	-0.0047
SDF (AOAC 991.43 method):	-0.0030	TDF (AOAC 985.29 method):	-0.0028

You do not need to run BLANKS with every set of samples. However, if you want to determine your own BLANK values, especially when you change chemical lots, **ANKOM recommends that the BLANK value in the IDF, SDF, and TDF calculations be the average of at least 18 BLANK values.**

If you determine your own BLANK values, you can overwrite the values currently in the MS-Excel spreadsheets.

13. IDF/SDF Analysis (AOAC 991.43)

An IDF/SDF analysis measures the amount of IDF and SDF within a given sample. This requires the use of ANKOM DF-I and DF-S filter bags. When starting a new run, the ANKOM^{TDF} Dietary Fiber Analyzer must have bags installed at all stations (a total of twelve bags).

NOTE: To enhance the productivity of your instrument, you can begin the IDF process of a new run while the SDF process of a previous run is finishing. See the "Productivity Enhancement" section of this manual for more details.

To perform an IDF/SDF analysis, follow the steps below.

13.1. Prepare chemicals and enzymes.

When using the ANKOM^{TDF} Dietary Fiber Analyzer for the AOAC 991.43, AACC 32-07.01, and NMKL 129,2003 methods use the chemicals and enzymes referred to therein. See Appendix A of this manual for the list of chemicals and enzymes and the instructions for how to prepare them for use in this instrument.

13.2. For samples that have a fat content of 10% or higher, de-fat your samples as needed according to the official methods or internal SOPs.

13.3. Label the filter bags using a Solvent Resistant Marker.



13.4. Prepare for data collection.

You will need a place to store the data collected during this analysis. For your convenience a USB flash drive was included with the instrument. This USB includes a Calculation Template MS-Excel file that can be used for this analysis. Please read the "Instructions" tab in the Calculation Template MS-Excel file for information about the spreadsheets.

13.5. Weigh filter bags.

IMPORTANT: Using a Bag Weigh Holder is critical to eliminate the effects of static electricity during the weighing process.

Roll or fold each bag and place it in a tared Bag Weigh Holder. Place the Bag Weigh Holder in the center of a balance and record the weight.



NOTE: Because different balances have different sensitivities, the Bag Weigh Holder should be placed in the center of the balance for best results.

13.6. Weigh Diatomaceous Earth (DE).

DE is used during fiber analysis to enhance the flocculation and filtration of the SDF fraction. Place approximately 1g of DE in each of six tared and numbered tins/weigh boats and record the weights.

13.7. Weigh Samples.

Place 0.5 ± 0.05 g of sample in each of six tared and numbered tins/weigh boats and record the weights.

NOTE: A larger sample (1.0 g) can be used if a larger aliquot is needed to improve precision.

13.8. Turn the instrument power on.

When you turn the power on, the instrument will run through an initialization process and the Control Panel will turn on.

13.9. Confirm Nitrogen Supply and pressure ranges.

Make sure the Nitrogen supply in your lab is connected to the instrument and turned on. The High Pressure Gauge on the left of the instrument should be set between 50-55 psi. The Low Pressure Gauge on the right side of the instrument should be set at 4 psi. The accuracy of the Low Pressure Gauge should be checked prior to each run by pressing the "Pressurize SDF" button on the control panel twice.



13.10. On the Touch Screen Display, select the instrument function you would like to perform.

The Control Panel on the ANKOM^{TDF} Dietary Fiber Analyzer uses Touch Screen technology. To operate the instrument, you will press identified buttons on the Touch Screen Display and buttons below the screen.

When your instrument is ready to operate, the following screen will be displayed.

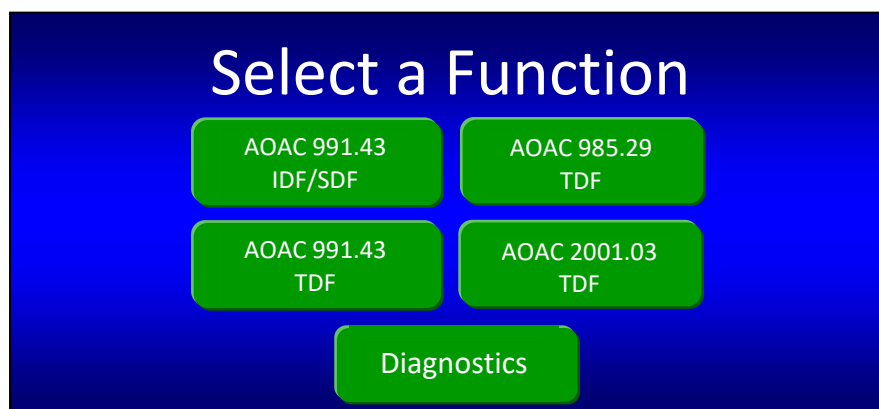

NOTE: Although the instrument works in accordance with AACC and NMKL methods, the Touch Screen Display only refers to the AOAC methods.

13.10.1. To avoid a Vacuum Sensor Fault, the lines must be charged if: this is the first time the instrument is being operated after being installed, if the instrument has sat unused for a period of time (and was flushed according to Appendix C), or if this is the first time used after tubing was replaced. To charge the lines, attach the Flush Tubing Assembly and connect it to the Water Container filled with Deionized (DI) or Distilled (DW), then follow the steps below.

13.10.1.1. Press the **Diagnostics** button on the "Select a Function" screen. The following screen will be displayed.

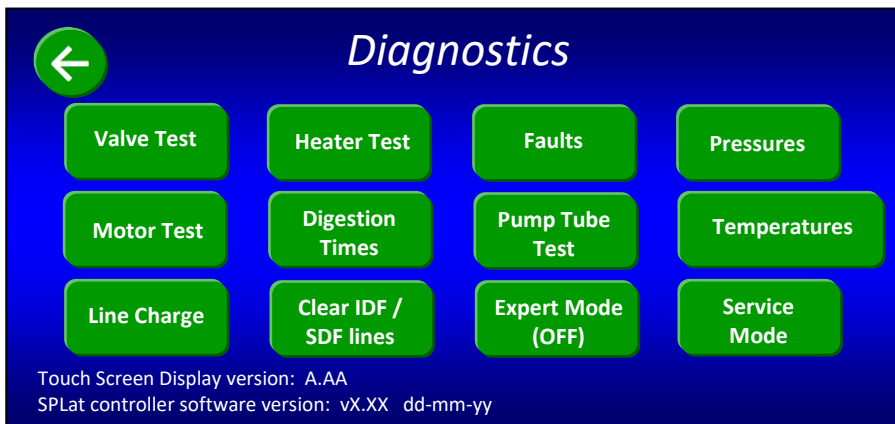

13.10.1.2. Press the **Line Charge** button. The following screen will be displayed.

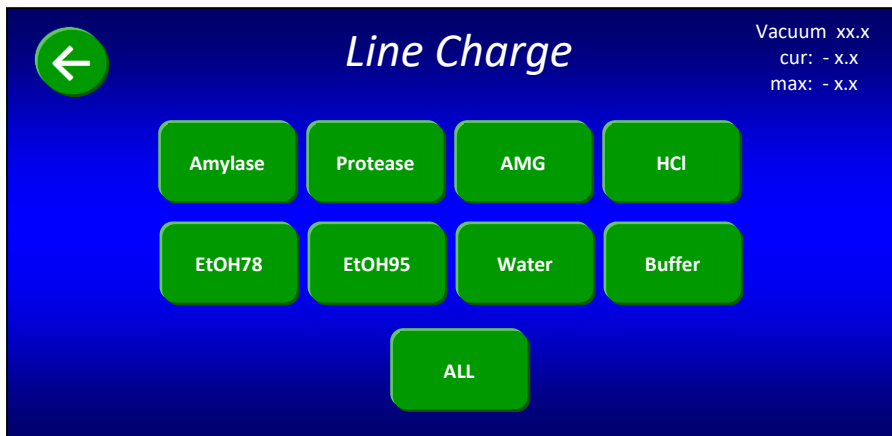

- 13.10.1.3. Press the **ALL** button to charge all the lines. Each button will change color as the associated line is being charged. All lines are charged when all the buttons return to their original green color.
- 13.10.1.4. Press the back  button twice. The following "Select a Function" screen will be displayed again.

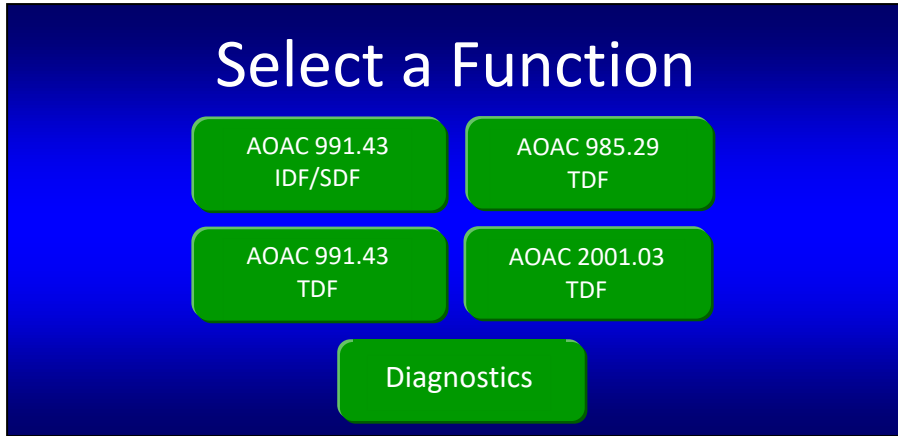

- 13.10.1.5. Press the **AOAC 991.43 IDF/SDF** button. The following screen will be displayed.

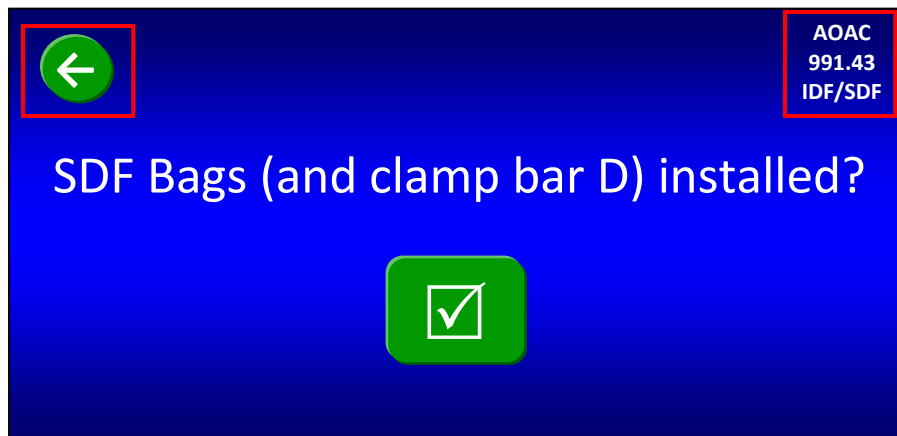

Notice that the function you selected is now displayed in the top right corner of the screen and a back  button is displayed in the top left corner of the screen.

13.11. Install SDF filter bags on the ANKOM^{TDF} Dietary Fiber Analyzer.

13.11.1. Remove Clamp Bars A, B, C, and D by lifting them off of the locator rods.

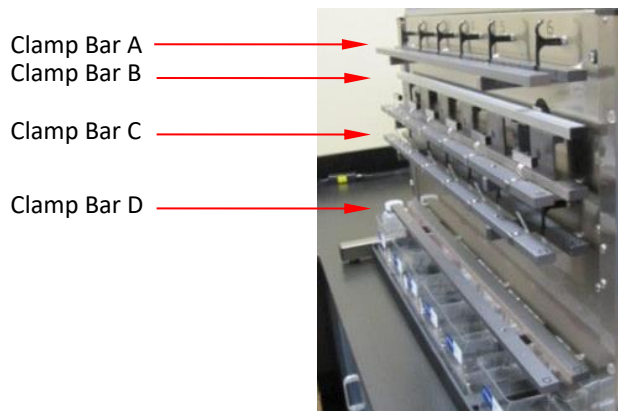

13.11.2. Gently pull the black SDF Delivery Nozzle out toward you.



13.11.3. Place a labeled and weighed SDF bag up underneath the SDF Delivery Nozzle so that the Delivery Nozzle is inside the top part of the bag. Pull the bag up so that the top of the bag is about 35 mm (1.375 inches) above the top of Clamp Bar C and return the Delivery Nozzle to its original position. This will hold the back of the bag in place.



IMPORTANT:

As part of normal operation, solution from the IDF bag will flow into the SDF bag. Therefore, when installing the SDF filter bags it is very important to position them high enough vertically so that at least 20 mm (0.75 inches) of the filter part of the IDF bag can fit inside the top of the SDF bag.

13.11.4. With the bag being held by the Delivery Nozzle, center it horizontally between the lines on the back part of Clamp Bar C.



13.11.5. Repeat previous steps for all six stations.

13.11.6. Re-install Clamp Bar D by setting it on the locator rods. Make sure the letter is on the top of the bar and the rubber gasket is facing in toward the instrument.

13.11.7. Flatten the bags to remove any wrinkles.

13.11.8. With fingers away from the clamp bars, press the check mark (☑) button on the Touch Screen Display to pinch the bags just above the filter. The following screen will be displayed.

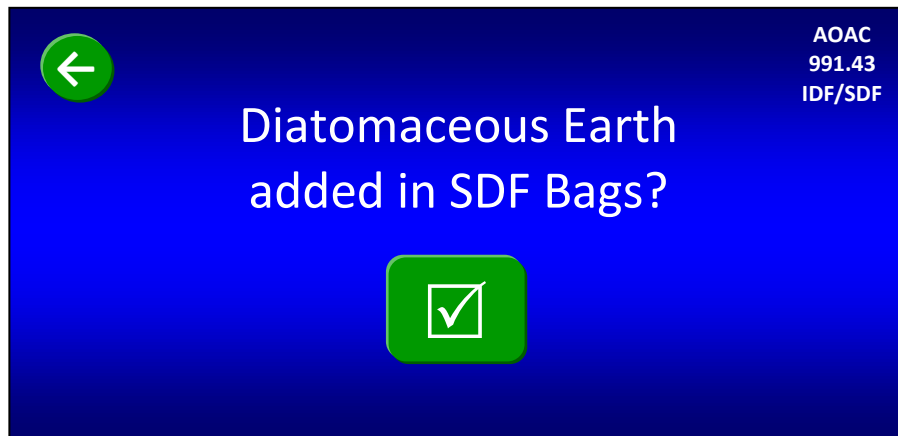

13.12. Add DE to the SDF filter bags on the ANKOM^{TDF} Dietary Fiber Analyzer.

13.12.1. Open the top of the SDF bag and add the #1 weigh tin/weigh boat of DE to the bag by folding the tin and then dipping it down into the bag below the tip of the Delivery Nozzle.



IMPORTANT: When adding DE to the filter bags it is very important to keep it below the tip of the Delivery Nozzle so that the DE material can be properly rinsed.

- 13.12.2. If necessary, rinse the tin/weigh boat with no more than 3 ml of 78% EtOH to ensure complete transfer.
- 13.12.3. Repeat steps for all six stations.
- 13.12.4. Press the check mark (☑) button on the Touch Screen Display. The following screen will be displayed.

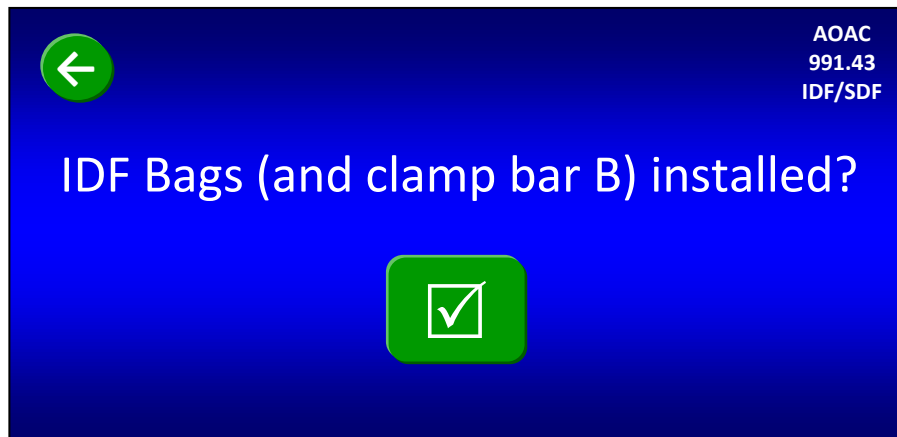

NOTE: After you confirm that the DE is added, the Clamp Bar D button on the Control Panel is disabled until the SDF process completes.

13.13. Install IDF filter bags on the ANKOM^{TDF} Dietary Fiber Analyzer.

- 13.13.1. Gently pull the black IDF Delivery Nozzle out toward you.



- 13.13.2. Place a labeled and weighed IDF bag up underneath the Delivery Nozzle so that the Delivery Nozzle is inside the top part of the bag. Pull the bag up so that the top of the filter part of the IDF bag is just below the bottom of Clamp Bar B and return the Delivery Nozzle to its original position. This will hold the back of the bag in place.
- 13.13.3. With the bag held by the Delivery Nozzle, center it horizontally between the Centering Lines on the back part of Clamp Bar A.

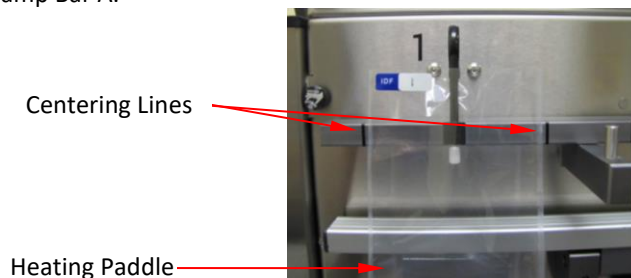

IMPORTANT: For proper mixing during the IDF process the IDF bags must be horizontally centered over the Heating Paddles and between the Centering Lines on the back part of Clamp Bar A.

- 13.13.4. Place at least 20 mm (0.75 inches) of the filter section of the IDF bag inside the top of the SDF bag to allow for the flow of liquid into the SDF bag after the IDF process is complete.

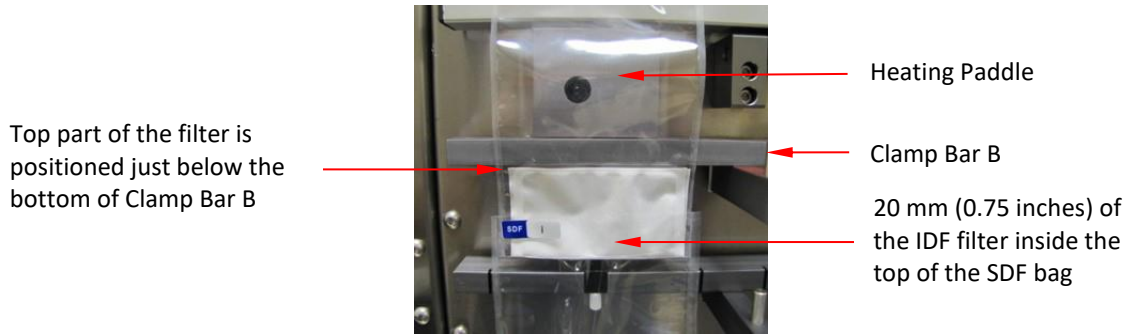

- 13.13.5. Repeat steps for all six stations.
- 13.13.6. Re-install Clamp Bar B by setting it on the locator rods. Make sure the letter is on the top of the bar and the rubber gasket is facing in toward the instrument.
- 13.13.7. Flatten the IDF bags to remove any wrinkles.
- 13.13.8. With fingers away from the clamp bars, press the check mark (☑) button on the Touch Screen Display to pinch the IDF bags just above the filter. The mixing pads will make contact with the bags when Clamp Bar B pinches the IDF bags. The following screen will be displayed.



13.14. Add samples to the IDF bags.

- 13.14.1. Open the top of the IDF bag and transfer the sample from the #1 tin/ weigh boat into the IDF bag by folding the tin and then dipping it down into the bag below the tip of the Delivery Nozzle.



IMPORTANT: When adding sample to the filter bags it is very important to keep it below the tip of the Delivery Nozzle so that it can be properly rinsed.

- 13.14.2. Rinse the tin/ weigh boat with as little Deionized (DI) or Distilled (DW) water as possible (maximum of 3 ml) to ensure complete transfer.
- 13.14.3. Repeat steps for all IDF stations.
- 13.14.4. Re-install Clamp Bar A by setting it on the locator rods. Make sure the letter is on the top of the bar and the rubber gasket is facing in toward the instrument.
- 13.14.5. Press the check mark (☑) button on the Touch Screen Display. The following screen will be displayed.



- 13.14.6. Make sure that all clamp bars are installed with the letter on the top of the bar and the rubber gasket facing in toward the instrument. Press the check mark (☑) button on the Touch Screen Display. The following screen will be displayed.

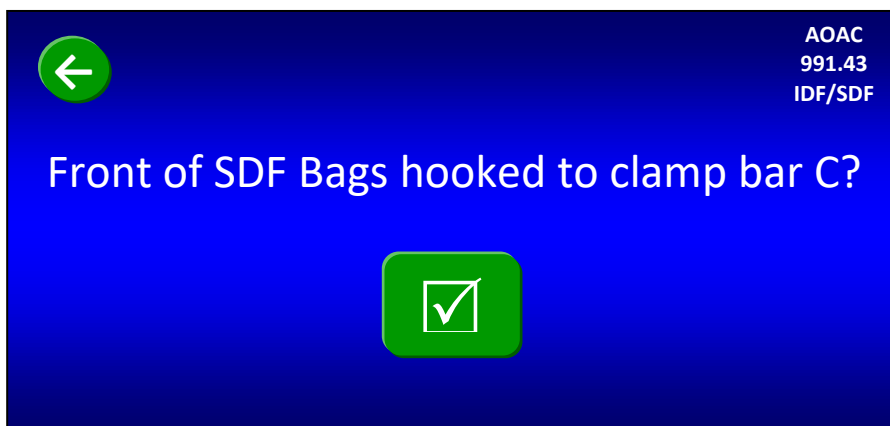

13.15. Hook the front of each SDF bag in place.

13.15.1. Secure the front of SDF filter bags onto the hooks located on the front part of Clamp Bar C by pulling up the middle section of the front of the filter bag evenly and tightly, lean the bag against the hook as the bag is lowered, allowing the bag to catch onto the hook. There should be at least a ¼" of the top of the bag sitting above the hook.



Hook on front part of
Clamp Bar C

NOTE: Hooking the bags in place will put a physical hole in the front of each SDF bag.

13.15.2. Press the check mark (☑) button on the Touch Screen Display. If you ran a method other than 991.43 prior to this run, the following screen will be displayed.

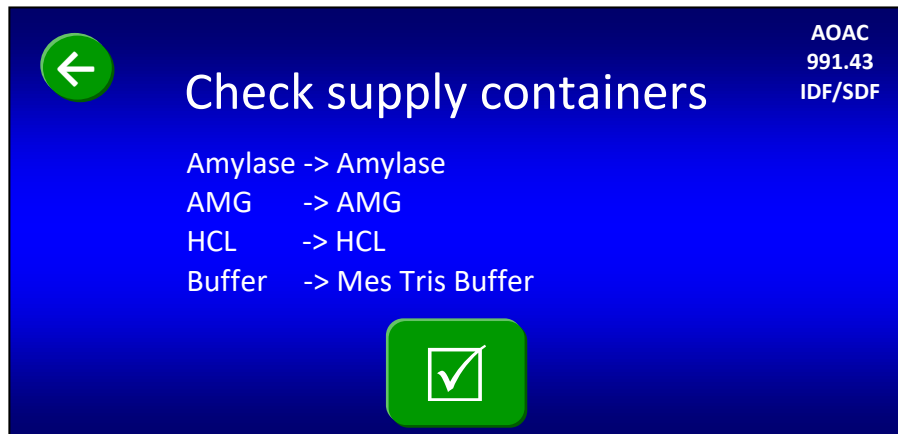

13.16. Verify that the fluid containers have the correct fluids for this procedure.

Verify that the fluid supply containers are configured according to the screen above and press the check mark (☑) button. The "Fluid levels correct?" screen will be displayed.

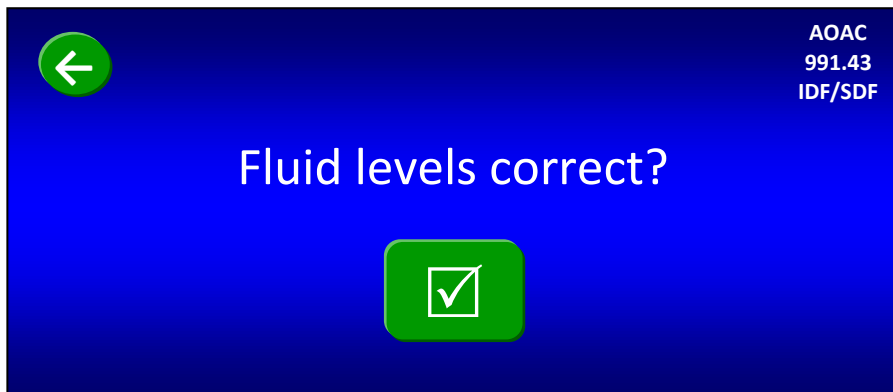
**13.17. Fill fluid containers.**

To ensure that you have enough fluids to run a complete IDF/SDF procedure, you must begin with fluid levels above the Minimum Level lines on the chemical containers and at least 15 ml of each enzyme. Add fluids and enzymes, as necessary.

IMPORTANT: Do NOT leave the enzyme ports on the instrument open to the air or the enzymes in the valves may dry up and plug the ports.

With all fluid containers filled to the proper levels, press the check mark (☑) button on the Touch Screen Display. The following screen will be displayed.

**13.18. Confirm Nitrogen Supply ON.**

Confirm the high-pressure gauge on the left of the instrument shows 50-55 psi. The low-pressure gauge on the right side of the instrument should be set at 4 psi.

Press the check mark (☑) button on the Touch Screen Display. The following screen will be displayed.

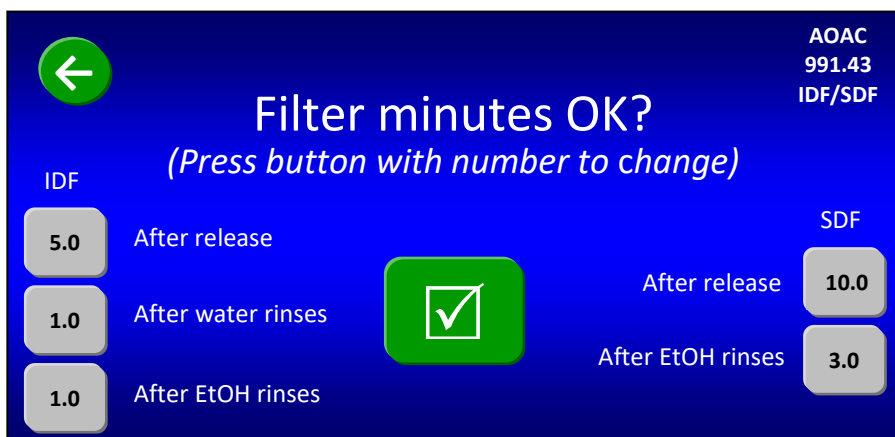

13.19. Set filter times (in minutes).

Because different samples take different amounts of time to filter, the above screen allows you to set your filter times. To change any of the times shown on the screen, press the specific gray button. A number pad will be displayed that will allow you to enter the time that you want. The times you enter will remain until you change them again.

NOTE: The initial filter times shown when you first run the instrument are based on factory experience. During filtration, the computer allows you to bypass the filter time if you notice the filtering is complete. The computer also allows you to add time during filtering if needed (see the "Status Screen" section of this manual for more detail).

When all of the times shown on the screen are what you want, press the check mark (☑) button on the Touch Screen Display. The following screen will be displayed.

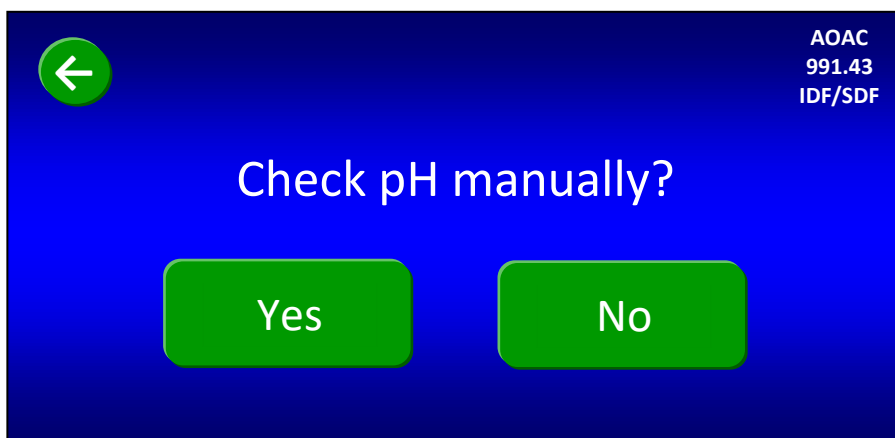

13.20. Set the Manual pH Check.

If you plan to check the pH after the required HCl is added (during the IDF process), press the **Yes** button on the screen above. Otherwise, press the **No** button. The following screen will be displayed.

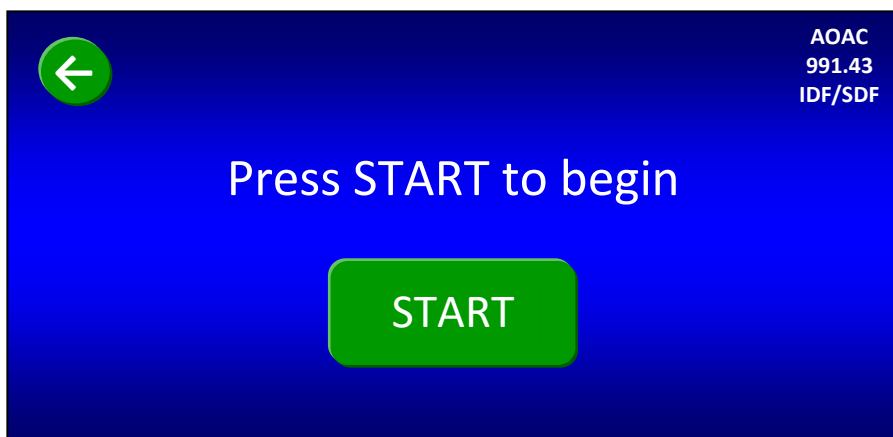

13.21. Start the instrument.

The instrument is now completely set up and ready to automatically run the IDF/SDF procedure. Press the **START** button to begin. At the beginning of each new run, the instrument automatically runs a tube integrity test.

For the first run after a power-up cycle, or for the first run after the instrument has been idle for twelve hours, the following screen will be displayed.

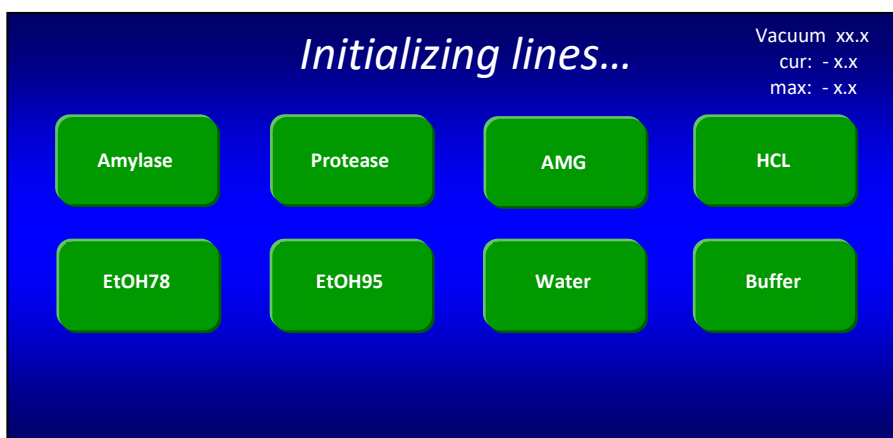

If the fluid lines are already charged properly, or when the line charge is complete, the following screen will be displayed.

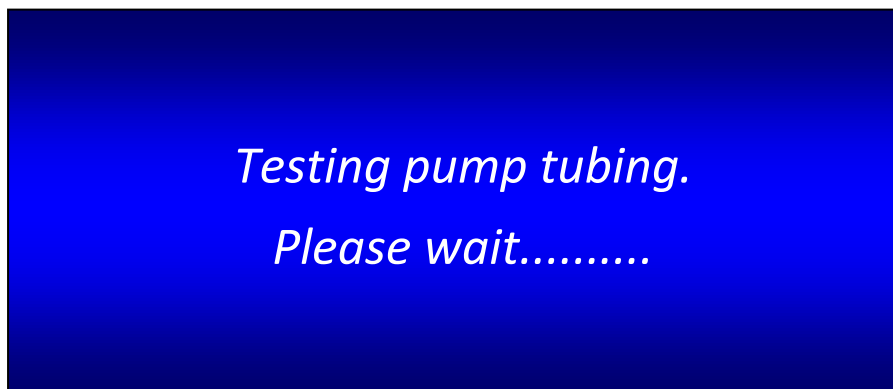

When the tube integrity check is complete, the instrument will automatically execute the IDF/SDF procedure stopping only for faults, aborts, and manual pH measurement (if enabled). The Status screen will show actions and faults as they occur during the automatic operation.

13.22. Manually measure pH.

One of the questions you are asked before starting the automated procedure is: "Check pH manually?" If you answered "Yes" to this question, the instrument will stop after adding the required HCl, open Clamp Bar A, display the screen below, and make a sound to remind you to manually measure pH and adjust to 4.0 - 4.7 if necessary.

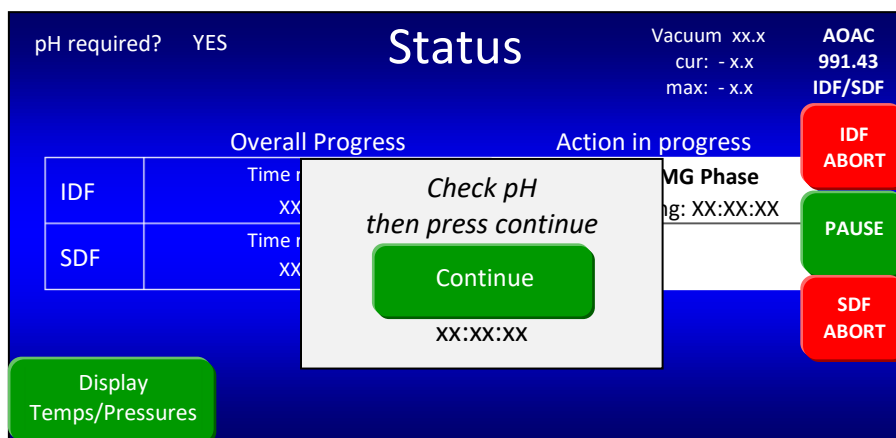

When measuring pH, use a probe that can be easily rinsed (with DI or DW water) to avoid loss of sample. If you add 0.5N HCl or base to adjust the pH, you must mix the solution to get an accurate pH reading. To manually mix the solution, press the outside of the bag with your fingers just above Clamp Bar B multiple times.



When you have completed the pH measurement process, press the **Continue** button on the Status screen. You will see "COMPLETE" next to "pH required?" in the upper left corner of the screen.

13.23. Rinse the IDF filter bags with acetone.

After the instrument has completed an IDF process, the IDF residue that has been collected in the IDF bag must be manually rinsed twice with acetone. It is recommended that you use an ANKOM TDF51 Rinse Stand (sold separately) for rinsing filter bags with acetone.

To rinse the IDF filter bags with acetone using the ANKOM TDF51 Rinse Stand, follow the steps below.

- 13.23.1. Remove the IDF bags from the instrument.
- 13.23.2. Place the bags on the Rinse Stand by sliding the back part of each bag under the pinch mechanism. Keep the top of the bag open.



- 13.23.3. Using a wash bottle, squirt acetone completely around the inside polypropylene surfaces of each bag two times, making sure that all residue on the surfaces is rinsed down into the filter.
- 13.23.4. After two full rinses, target any sample still clinging to the walls of the bag with Acetone, making sure all the sample is pushed into the filter part of the bag. Allow acetone to evaporate from the bags for 30-40 minutes.



Hazardous Materials – Do NOT heat seal or place bags in an oven until all acetone has evaporated.

- 13.23.5. With your Heat Sealer (HS/HSi) set between 3 and 4 (settings may vary depending on the heat sealer and the power source), press the Heat Sealer arm down. **Hold the arm down for 3 to 4 seconds after the light goes out** to seal each bag just above the filter. This keeps all residue contained to the filter area while handling the bags.



- 13.23.6. Place each bag in the Drying Rack.

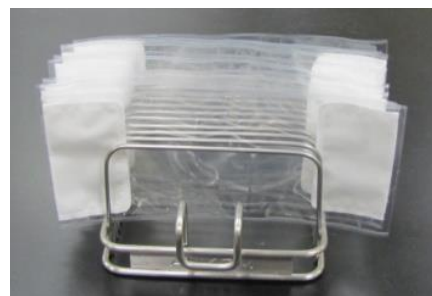

13.24. Rinse the SDF filter bags with acetone.

After the instrument has completed an SDF process the SDF residue that has been collected in the SDF bag must be manually rinsed with acetone. It is recommended that you use an ANKOM TDF51 Rinse Stand for rinsing filter bags with acetone.

To rinse the SDF filter bags with acetone using the ANKOM TDF51 Rinse Stand, follow the steps below.

- 13.24.1. Remove the SDF bags from the instrument.
- 13.24.2. Place the bags on the Rinse Stand by sliding the back part of each bag under the pinch mechanism. Keep the top of the bag open.
- 13.24.3. Using a wash bottle, squirt acetone completely around the inside polypropylene surfaces of each bag two times, making sure that all residue on the surfaces is rinsed down into the filter.
- 13.24.4. After two full rinses, target any sample still clinging to the walls of the bag with Acetone, making sure all the sample is pushed into the filter part of the bag.
- 13.24.5. Allow acetone to evaporate from the bags for 30-40 minutes.



Hazardous Materials – Do NOT heat seal or place bags in an oven until all acetone has evaporated.

- 13.24.6. Seal each bag just above the filter to keep all residue contained to the filter area while handling the bags.

NOTE:

Sealing each bag as close to the filter as possible allows you to trim the maximum amount of polypropylene from the bag before determining the protein content.

- 13.24.7. Place each bag in the Drying Rack.

13.25. Dry the IDF and SDF filter bags.

- 13.25.1. Make sure your oven is 105°C at the location where the bags will be placed.
- 13.25.2. Place the Drying Rack with the filter bags in the oven and dry to constant weight (90 minutes per the method).
- 13.25.3. When dry, remove all filter bags from the oven and place the IDF and SDF bags in separate desiccant pouches (X45).

13.26. Weigh the IDF residue.

- 13.26.1. Remove only one IDF filter bag from the desiccant pouch at a time.
- 13.26.2. Roll or fold the bag, place it in a tared Bag Weigh Holder (BWH), and place the BWH in the center of a balance.
- 13.26.3. Record the weight of the filter bag.
- 13.26.4. Repeat steps 25.1 – 25.3 for each IDF filter bag used in the fiber analysis.

13.27. Weigh the SDF residue.

- 13.27.1. Remove only one SDF filter bag from the desiccant pouch at a time.
- 13.27.2. Roll or fold the bag, place it in a tared Bag Weigh Holder (BWH), and place the BWH in the center of a balance.
- 13.27.3. Record the weight of the filter bag.
- 13.27.4. Repeat steps 26.1 – 26.3 for each SDF filter bag used in the fiber analysis.

13.28. Determine the Protein content within the IDF and SDF residue.

See the "Protein Determination" section of this manual for recommended procedures.

13.29. Determine the Ash content within the IDF and SDF residue.

See the "Ash Determination" section of this manual for recommended procedures.

13.30. Calculate the % IDF value.

% IDF	=	$\left[\frac{[(R_1 + R_2)/2] - P - A - B}{(M_1 + M_2)/2} \right] \times 100$	X 100
	=	$\left[\frac{[((f_{F1} - f_{S1}) + (f_{F2} - f_{S2}))/2] - P - A - B}{(M_1 + M_2)/2} \right] \times 100$	X 100
Where:	M_1, M_2	=	Original wt of duplicate samples adjusted for pre-treatment fat and sugar losses (g)
	R_1, R_2	=	Residue for duplicate samples (g)
	f_F	=	Final Filter Bag with residue (g)
	f_S	=	Initial Filter Bag (g)
	P	=	Protein of residue and bag (g)
	A	=	Ash of residue and bag (g)
	B	=	Blank (g)
		=	$[(BR_1 + BR_2)/2] - P_B - A_B$
		=	$[(f_{BF1} - f_{BS1}) + (f_{BF2} - f_{BS2})]/2 - P_B - A_B$
	BR_1, BR_2	=	Residue for duplicate blanks (g)
	f_{BF}	=	Final Blank Filter Bag (g)
	f_{BS}	=	Initial Blank Filter Bag (g)
	P_B	=	Protein of Blank Filter Bag (g)
	A_B	=	Ash of Blank Filter Bag (g)

13.31. Calculate the % SDF value.

% SDF	=	$\left[\frac{[(R_1 + R_2)/2] - P - A - B}{(M_1 + M_2)/2} \right] \times 100$	X 100
	=	$\left[\frac{[((f_{F1} - f_{S1} - D_1) + (f_{F2} - f_{S2} - D_2))/2] - P_1 - (A_2 - D_2) - B}{(M_1 + M_2)/2} \right] \times 100$	X 100
Where:	M_1, M_2	=	Original wt of duplicate samples adjusted for pre-treatment fat and sugar losses (g)
	R_1, R_2	=	Residue for duplicate samples (g)
	f_F	=	Final Filter Bag with residue (g)
	f_S	=	Initial Filter Bag (g)
	D	=	Original wt of Diatomaceous Earth (g)
	P	=	Protein of residue and bag (g)
	A	=	Ash of residue and bag (g)
	B	=	Blank (g)
		=	$[(BR_1 + BR_2)/2] - P_B - (A_B - D_B)$
		=	$[(f_{BF1} - f_{BS1} - D_{B1}) + (f_{BF2} - f_{BS2} - D_{B2})]/2 - P_{B1} - (A_{B2} - D_{B2})$
	BR_1, BR_2	=	Residue for duplicate blanks (g)
	f_{BF}	=	Final Blank Filter Bag (g)
	f_{BS}	=	Initial Blank Filter Bag (g)
	P_B	=	Protein of Blank Filter Bag (g)
	A_B	=	Ash of Blank Filter Bag (g)
	D_B	=	Original wt of Diatomaceous Earth in Blank Filter Bag (g)

13.32. Calculate the % TDF value by adding the % IDF and % SDF values.

14. TDF Analysis (AOAC 991.43)

A TDF analysis directly measures the amount of TDF within a given sample without separately measuring the IDF and SDF fractions. TDF can be determined using multiple methods. This section describes the procedure for using the ANKOM^{TDF} Dietary Fiber Analyzer to determine TDF based on the AOAC 991.43 method.

This analysis requires an SDF filter bag (ANKOM DF-S) for the precipitation process and a non-filter IDF *Flow-Thru* bag (ANKOM DF-FT) for the digestion process. When starting a new run, the ANKOM^{TDF} Dietary Fiber Analyzer must have bags installed at all stations (a total of twelve bags).

NOTE: To enhance the productivity of your instrument, you can begin the IDF process of a new run while the SDF process of a previous run is finishing. See the "Productivity Enhancement" section of this manual for more details.

To perform a TDF analysis, follow the steps below.

14.1. Prepare chemicals and enzymes.

When using the ANKOM^{TDF} Dietary Fiber Analyzer for the AOAC 991.43, AACC 32-07.01, and NMKL 129,2003 methods use the chemicals and enzymes referred to therein. See Appendix A of this manual for the list of chemicals and enzymes and the instructions for how to prepare them for use in this instrument.

14.2. For samples that have a fat content of 10% or higher, de-fat your samples as needed according to the official methods or internal SOPs.

14.3. Label the bags using a Solvent Resistant Marker.

IDF *Flow-thru* Bag
(shorter bag / no filter)



SDF Bag (longer
bag with filter)

14.4. Prepare for data collection.

You will need a place to store the data collected during this analysis. For your convenience, a USB flash drive was included with the instrument. This USB includes a Calculation Template MS-Excel file that can be used for this analysis. Please read the "Instructions" tab in the Calculation Template MS-Excel file for information about the spreadsheets.

14.5. Weigh filter bags.

IMPORTANT: Using a Bag Weigh Holder is critical to eliminate the effects of static electricity during the weighing process.

Roll or fold each bag and place it in a tared Bag Weigh Holder. Place the Bag Weigh Holder in the center of a balance and record the weight.



NOTE: Because different balances have different sensitivities, the Bag Weigh Holder should be placed in the center of the balance for best results.

14.6. Weigh Diatomaceous Earth (DE).

DE is used during fiber analysis to enhance the flocculation and filtration of the SDF fraction. Place approximately 1g of DE in each of six tared and numbered tins/weigh boats and record the weights.

14.7. Weigh Samples.

Place 0.5 ± 0.05 g of sample in each of six tared and numbered tins/weigh boats and record the weights.

NOTE: A larger sample (1.0 g) can be used if a larger aliquot is needed to improve precision.

14.8. Turn the instrument power on.

When you turn the power on, the instrument will run through an initialization process and the Control Panel will turn on.

14.9. Confirm Nitrogen Supply and pressure ranges.

Make sure the Nitrogen supply in your lab is connected to the instrument and turned on. The High Pressure Gauge on the left of the instrument should be set between 50-55 psi. The Low Pressure Gauge on the right side of the instrument should be set at 4 psi. The accuracy of the Low Pressure Gauge should be checked prior to each run by pressing the "Pressurize SDF" button on the control panel twice.

High Pressure Gauge
50-55 psi (3.5-3.8 bar)



Low Pressure Gauge
4 psi (0.3 bar)

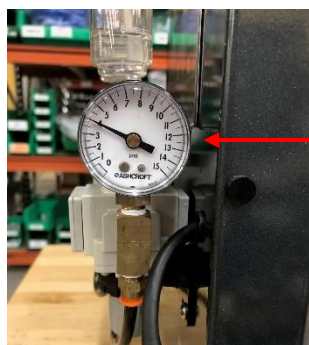

14.10. On the Touch Screen Display, select the instrument function you would like to perform.

The Control Panel on the ANKOM^{TDF} Dietary Fiber Analyzer uses Touch Screen technology. To operate the instrument, you will press identified buttons on the Touch Screen Display and buttons below the screen. When your instrument is initialized and ready to operate, the following screen will be displayed.

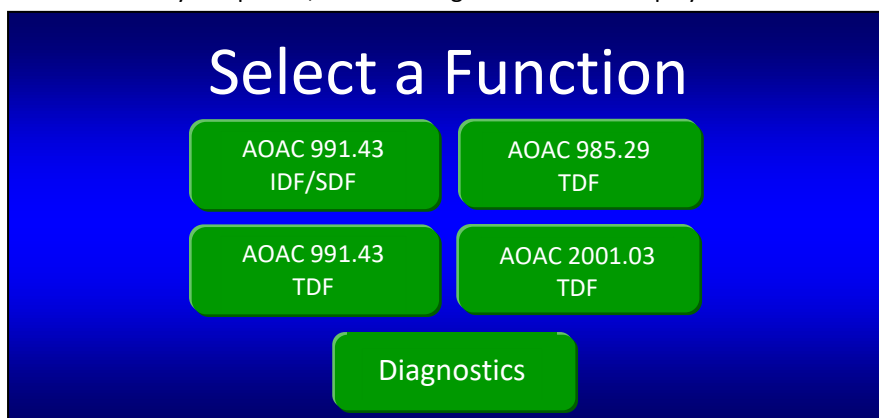

NOTE: Although the instrument works in accordance with AACC and NMKL methods, the Touch Screen Display only refers to the AOAC methods.

To avoid a Vacuum Sensor Fault, the lines must be charged if: this is the first time the instrument is being operated after being installed, if the instrument has sat unused for a period of time (and was flushed according to Appendix C), or if this is the first time used after tubing was replaced.

To charge the lines, attach the Flush Tubing Assembly and connect it to the Water Container filled with DI or DW water, then follow the steps below.

14.10.1. Press the **Diagnostics** button on the "Select a Function" screen. The following screen will be displayed.

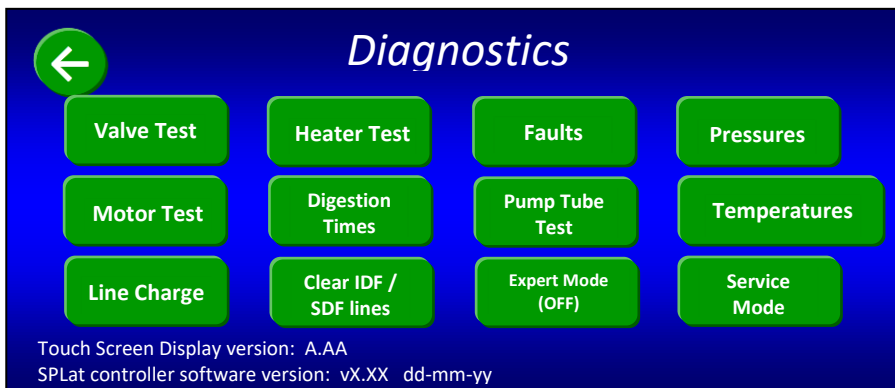

14.10.2. Press the **Line Charge** button. The following screen will be displayed.

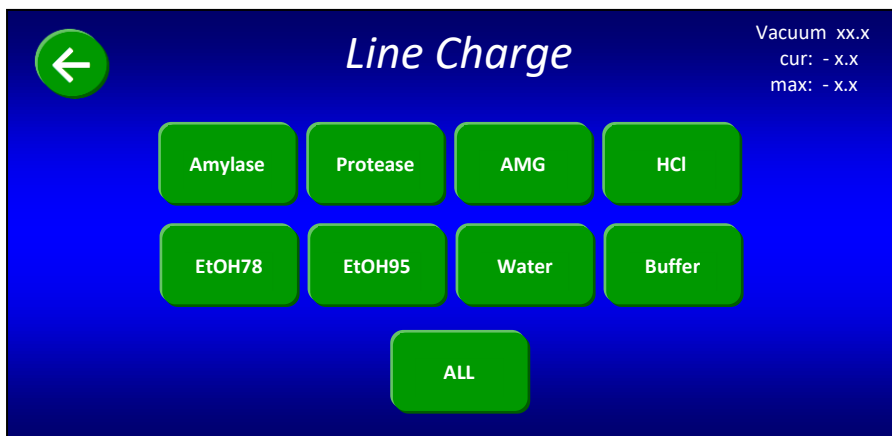

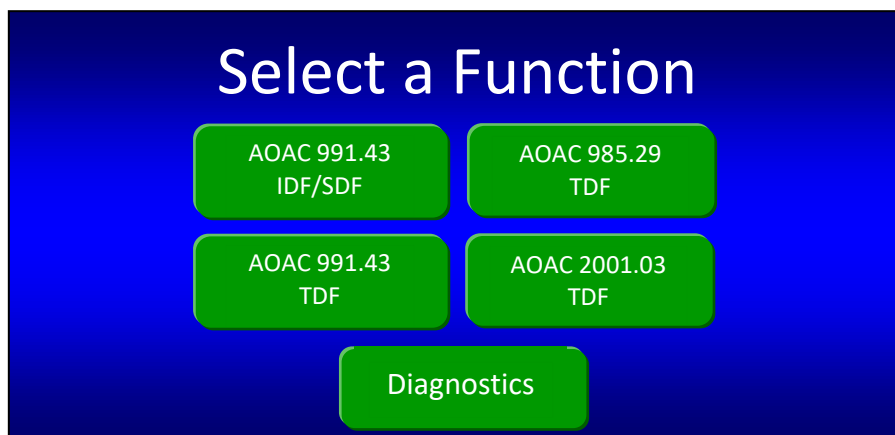

14.10.3. Press the **ALL** button to charge all of the lines. Each button will change color as the associated line is being charged. All lines are charged when all of the buttons return to their original green color.

14.10.4. Press the back  button twice. The following "Select a Function" screen will be displayed again.

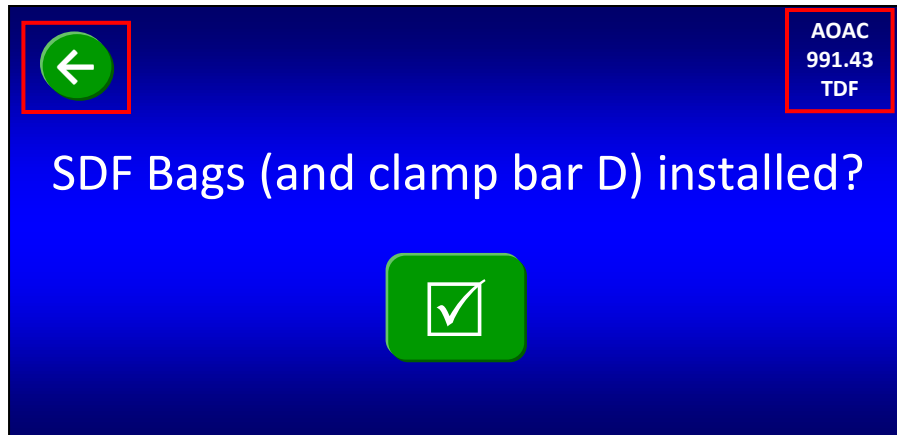

14.10.5. Press the **AOAC 991.43 TDF** button. The following screen will be displayed.



Notice that the function you selected is now displayed in the top right corner of the screen and a back  button is displayed in the top left corner of the screen.

14.11. Install SDF filter bags on the ANKOM^{TDF} Dietary Fiber Analyzer.

14.11.1. Remove Clamp Bars A, B, C, and D by lifting them off of the locator rods.

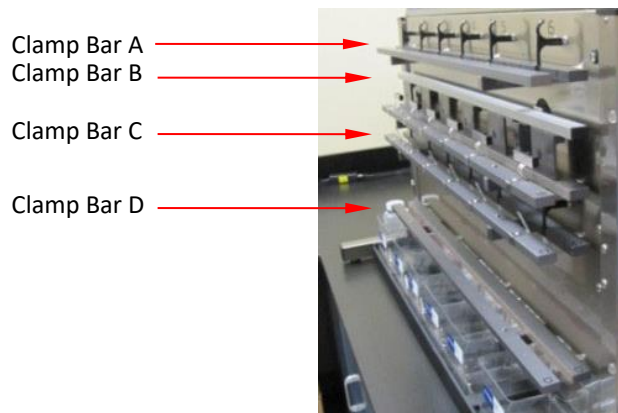

14.11.2. Gently pull the black SDF Delivery Nozzle out toward you.



- 14.11.3. Place a labeled and weighed SDF bag up underneath the SDF Delivery Nozzle so that the Delivery Nozzle is inside the top part of the bag. Pull the bag up so that the top of the bag is about 35 mm (1.375 inches) above the top of Clamp Bar C and return the Delivery Nozzle to its original position. This will hold the back of the bag in place.



IMPORTANT:

As part of normal operation, solution from the IDF *Flow-thru* bag will flow into the SDF bag. Therefore, when installing the SDF filter bags it is very important to position them high enough vertically so that at least 20 mm (0.75 inches) of the bottom of the IDF *Flow-thru* bag can fit inside the top of the SDF bag.

- 14.11.4. With the bag being held by the Delivery Nozzle, center it horizontally between the lines on the back part of Clamp Bar C.

Centering Lines



- 14.11.5. Repeat previous steps for all six stations.
14.11.6. Re-install Clamp Bar D by setting it on the locator rods. Make sure the letter is on the top of the bar and the rubber material is facing in toward the instrument.
14.11.7. Flatten the bags to remove any wrinkles.

14.11.8. With fingers away from the clamp bars, press the check mark (☑) button on the Touch Screen Display to pinch the bags. The following screen will be displayed.

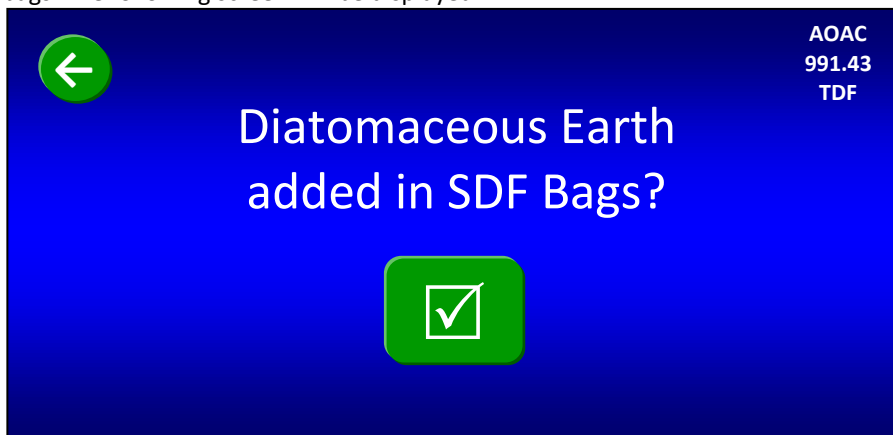

14.12. Add DE to the SDF filter bags on the ANKOM^{TDF} Dietary Fiber Analyzer.

14.12.1. Open the top of the SDF bag and add a weigh tin of DE to the bag by folding the tin and then dipping it down into the bag below the tip of the Delivery Nozzle.



IMPORTANT: When adding DE to the filter bags it is very important to keep it below the tip of the Delivery Nozzle so that the DE material can be properly rinsed.

14.12.2. Rinse the tin with no more than 3 ml of 78% EtOH to ensure complete transfer.

14.12.3. Repeat steps 14.11.1 – 14.11.2 for all six stations.

14.12.4. Press the check mark (☑) button on the Touch Screen Display. The following screen will be displayed.

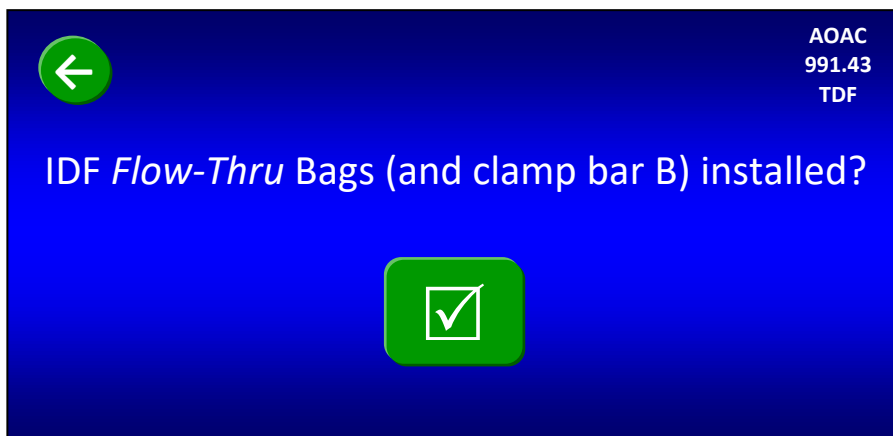

NOTE: After you confirm that the DE is added, the Clamp Bar D button on the Control Panel is disabled until the SDF process completes.

14.13. Install IDF *Flow-thru* bags on the ANKOM^{TDF} Dietary Fiber Analyzer.

Gently pull the black IDF Delivery Nozzle out toward you.



14.13.1. Place a labeled IDF *Flow-Thru* bag up underneath the Delivery Nozzle so that the Delivery Nozzle is inside the top part of the bag. Pull the bag up so that the top of the bag is about 35 mm (1.375 inches) above the top of Clamp Bar A and return the Delivery Nozzle to its original position. This will hold the back of the bag in place.

14.13.2. With the bag held by the Delivery Nozzle, center it horizontally between the Centering Lines on the back part of Clamp Bar A.

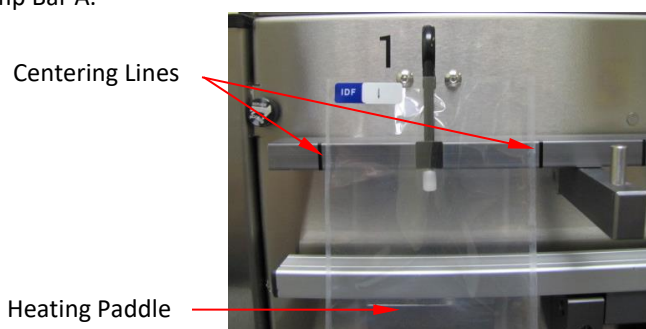

IMPORTANT: For proper mixing during the IDF process the IDF *Flow-thru* bags must be horizontally centered over the Heating Paddles and between the Centering Lines on the back part of Clamp Bar A.

14.13.3. Place at least 20 mm (0.75 inches) of the bottom of the IDF *Flow-Thru* bag inside the top of the SDF bag to allow for the flow of solution into the SDF bag after the digestion process is complete.

20 mm (0.75 inches) of the IDF *Flow-Thru* bag inside the top of the SDF bag

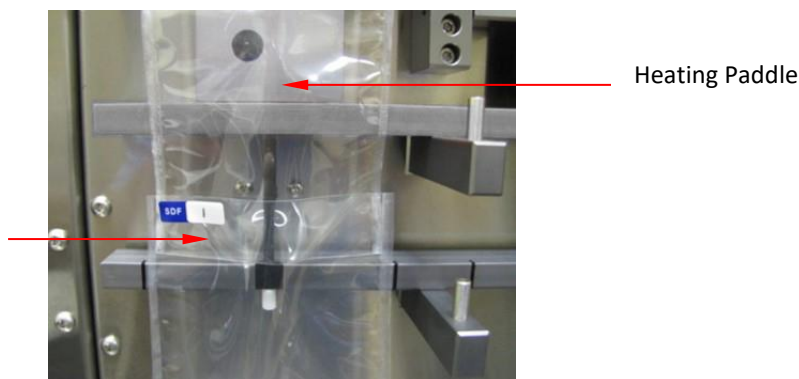

- 14.13.4. Repeat previous steps for all six stations.
- 14.13.5. Re-install Clamp Bar B by setting it on the locator rods. Make sure the letter is on the top of the bar and the rubber material is facing in toward the instrument.
- 14.13.6. Flatten the IDF Flow-Thru bags to remove any wrinkles.
- 14.13.7. With fingers away from the clamp bars, press the check mark (☑) button on the Touch Screen Display to pinch the IDF Flow-Thru bags. The mixing pads will make contact with the bags when Clamp Bar B pinches the IDF Flow-Thru bags. The following screen will be displayed.



14.14. Add samples to the IDF *Flow-thru* bags.

- 14.14.1. Open the top of the IDF *Flow-thru* bag and transfer the sample from a weigh tin into the bag by folding the tin and then dipping it down into the bag below the tip of the Delivery Nozzle.



IMPORTANT: When adding sample to the IDF *Flow-thru* bags it is very important to keep it below the tip of the Delivery Nozzle so that it can be properly rinsed.

- 14.14.2. Rinse the tin with no more than 3 ml of DI or DW water to ensure complete transfer.
- 14.14.3. Repeat steps for all IDF stations.
- 14.14.4. Re-install Clamp Bar A by setting it on the locator rods. Make sure the letter is on the top of the bar and the rubber material is facing in toward the instrument.
- 14.14.5. Press the check mark (☑) button on the Touch Screen Display. The following screen will be displayed.



- 14.14.6. Make sure that all clamp bars are installed with the letter on the top of the bar and the rubber material facing in toward the instrument. Press the check mark (☑) button on the Touch Screen Display. The following screen will be displayed.

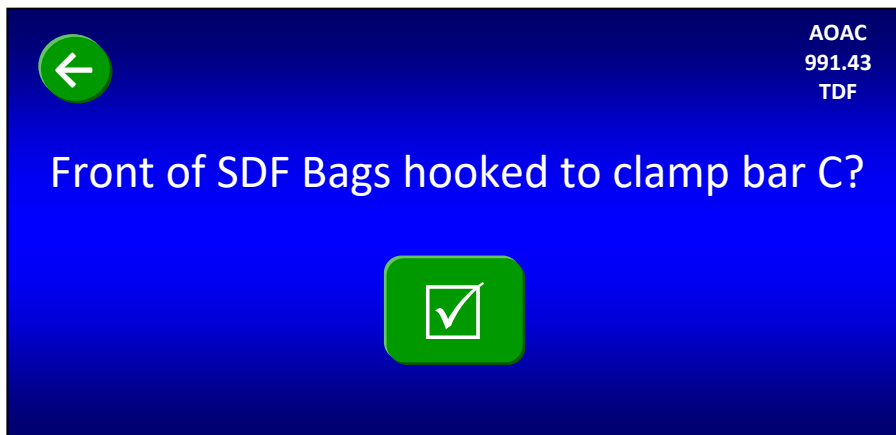

14.15. Hook the front of each SDF bag in place.

- 14.15.1. Secure the SDF filter bags in place with the hooks located on the front part of Clamp Bar C.



Hook on front part of
Clamp Bar C

NOTE: Hooking the bags in place will put a physical hole in the front of each SDF bag.

14.15.2. Press the check mark (☑) button on the Touch Screen Display. If you ran a method other than 991.43 prior to this run, the following screen will be displayed.

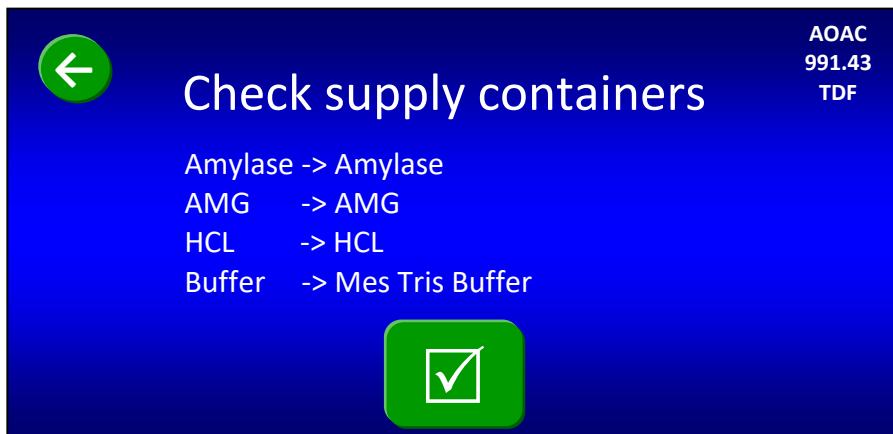

14.16. Verify that the fluid containers have the correct fluids for this procedure.

Verify that the fluid supply containers are configured according to the screen above and press the check mark (☑) button. The following screen will be displayed.

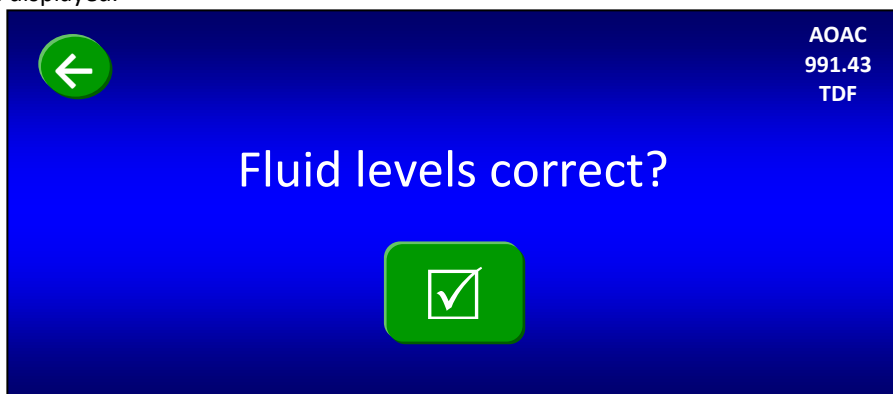

14.17. Fill fluid containers.

To ensure that you have enough fluids to run a complete TDF procedure, you must begin with fluid levels above the Minimum Level lines on the chemical containers and at least 15 ml of each enzyme. Add fluids and enzymes, as necessary.

IMPORTANT: Do NOT leave the enzyme ports on the instrument open to the air or the enzymes in the valves may dry up and plug the ports.

With all fluid containers filled to the proper levels, press the check mark (☑) button on the Touch Screen Display. The following screen will be displayed.



14.18. Confirm the Nitrogen Supply ON.

Confirm the high-pressure gauge on the left of the instrument shows 50-55 psi. The low-pressure gauge on the right side of the instrument should be set at 4 psi.

Press the check mark (☑) button on the Touch Screen Display. The following screen will be displayed.

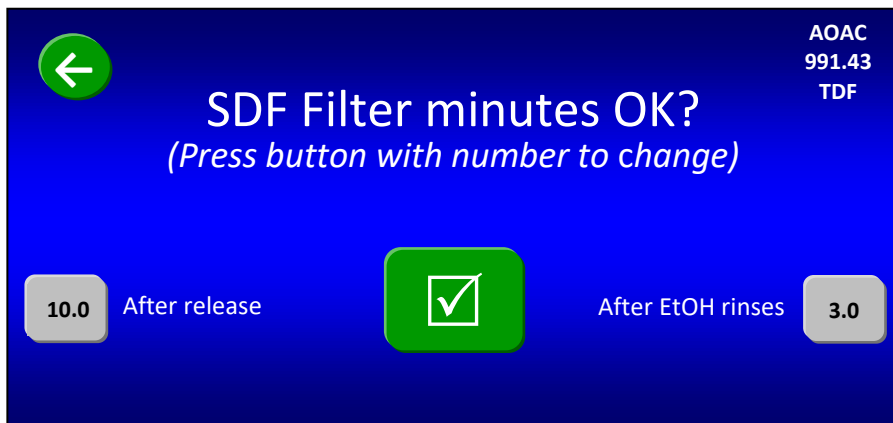

14.19. Set filter times (in minutes).

Because different samples take different amounts of time to filter, the above screen allows you to set your filter times. To change any of the times shown on the screen, press the specific gray button. A number pad will be displayed that will allow you to enter the time that you want. The times you enter will remain until you change them again.

NOTE: The initial filter times shown when you first run the instrument are based on factory experience. During filtration, the computer allows you to bypass the filter time if you notice the filtering is complete. The computer also allows you to add time during filtering if needed (see the "Status Screen" section of this manual for more detail).

When all of the times shown on the screen are what you want, press the check mark (☑) button on the Touch Screen Display. The following screen will be displayed.

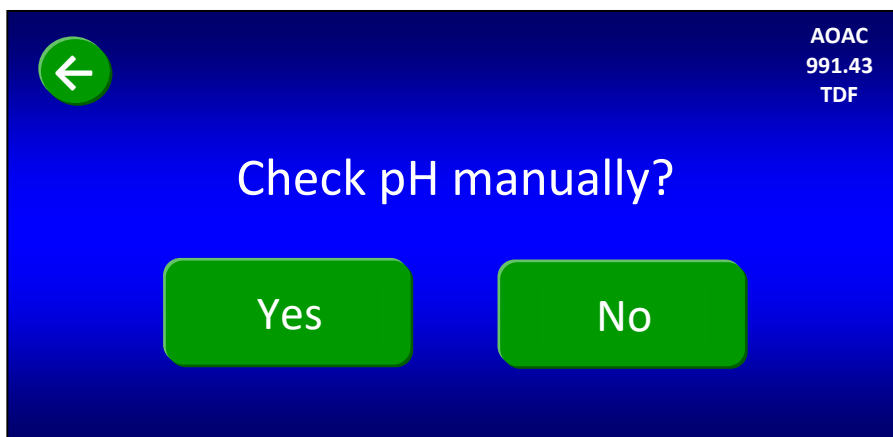

14.20. Set the Manual pH Check.

If you plan to check the pH after the required HCl is added (during the IDF process), press the **Yes** button on the screen above. Otherwise, press the **No** button. The following screen will be displayed.

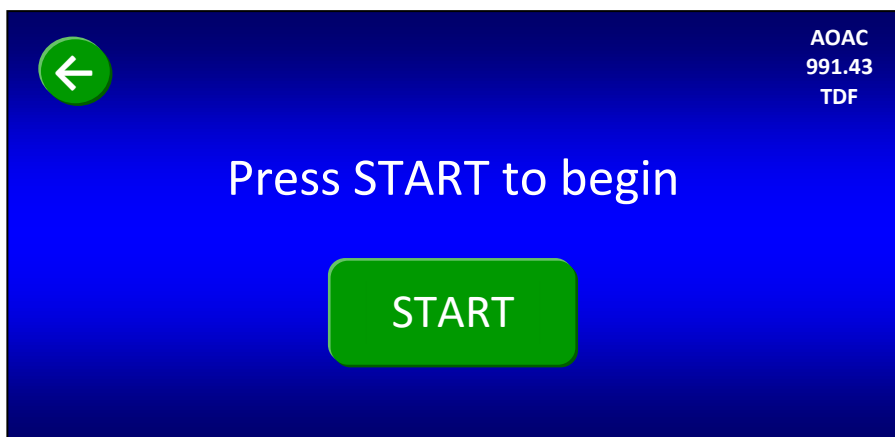

14.21. Start the instrument.

The instrument is now completely set up and ready to automatically run the TDF procedure. Press the **START** button to begin. At the beginning of each new run, the instrument automatically runs a tube integrity test.

For the first run after a power-up cycle, or for the first run after the instrument has been idle for twelve hours, the following screen will be displayed.

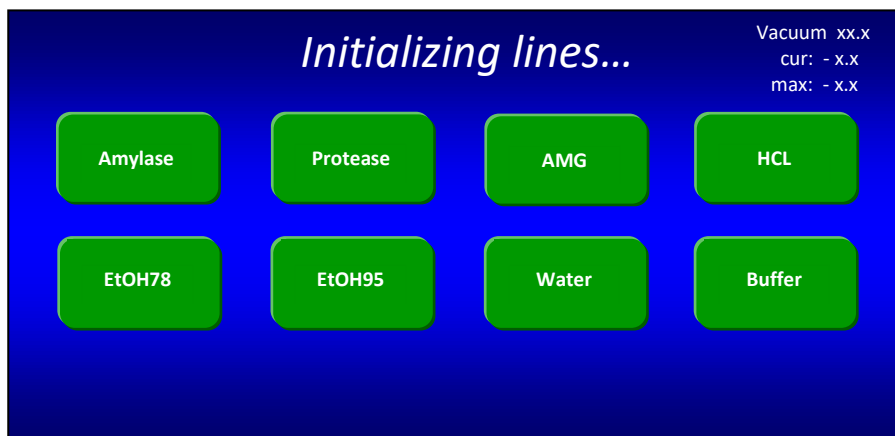

If the fluid lines are already charged properly, or when the line charge is complete, the following screen will be displayed.

When the tube integrity check is complete, the instrument will automatically execute the TDF procedure stopping only for faults, aborts, and manual pH measurement (if enabled). The Status screen will show actions and faults as they occur during the automatic operation.

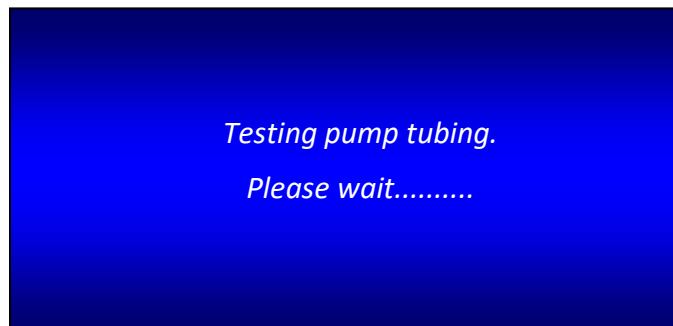

14.22. Manually measure pH.

One of the questions you are asked before starting the automated procedure is: "Check pH manually?" If you answered "Yes" to this question, the instrument will stop after adding the required HCl, open Clamp Bar A, display the screen below, and make a sound to remind you to manually measure pH and adjust to 4.0 - 4.7 if necessary.

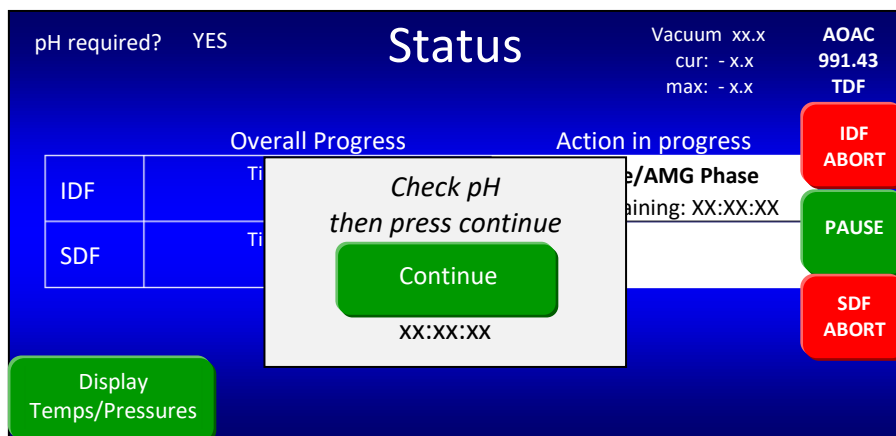

When measuring pH use a probe that can be easily rinsed (with DI or DW water) to avoid loss of sample. If you add 0.5N HCl or base to adjust the pH, you must mix the solution in order to get an accurate pH reading. To manually mix the solution, press the outside of the bag with your fingers just above Clamp Bar B multiple times.

When you have completed the pH measurement process, press the **Continue** button on the Status screen. You will see "COMPLETE" next to "pH required?" in the upper left corner of the screen.



14.23. Make sure that each sample is completely rinsed down into the SDF filter bags (as needed).

Since the IDF *Flow-thru* bags are not weighed before and after the process, it is important to make sure that each sample gets rinsed down into the SDF filter bag when the digestion process is complete.

If you notice sample sticking to an IDF *Flow-thru* bag, use 78% EtOH in a wash bottle to rinse as needed.

14.24. Rinse the SDF filter bags with acetone.

After the instrument has completed a TDF process the TDF residue that has been collected in the SDF bag must be manually rinsed with acetone. It is recommended that you use an ANKOM TDF51 Rinse Stand (sold separately) for rinsing filter bags with acetone.

To rinse the SDF filter bags with acetone using the ANKOM TDF51 Rinse Stand, follow the steps below.

- 14.24.1. Place the bags on the Rinse Stand by sliding the back part of the bag under the pinch mechanism. Keep the top of the bag open.



- 14.24.2. Using a wash bottle, squirt acetone completely around the inside polypropylene surfaces of each bag two times, making sure that all residue on the surfaces is rinsed down into the filter.



- 14.24.3. Repeat previous step so that each bag gets rinsed a total of two times. After the two full rinses, target any sample still clinging to the walls of the bag with Acetone making sure all of the sample is pushed into the filter part of the bag.

- 14.24.4. Allow acetone to evaporate from the bags for 30-40 minutes.



Hazardous Materials – Do NOT heat seal or place bags in an oven until all acetone has evaporated.

- 14.24.5. With your Heat Sealer (HS/ HSi) set between 3 and 4 (settings may vary depending on the heat sealer and the power source), press the Heat Sealer arm down. **Hold the arm down for 3 to 4 seconds after the light goes out** to seal each bag just above the filter. This keeps all residue contained to the filter area while handling the bags.



- 14.24.6. Place each bag in the Drying Rack.



14.25. Dry the SDF filter bags.

- 14.25.1. Make sure your oven is 105°C at the location where the bags will be placed.
- 14.25.2. Place the Drying Rack with the filter bags in the oven and dry to constant weight (a minimum 90 minutes).
- 14.25.3. When dry, remove SDF filter bags from the oven and place them in a desiccant pouch (X45) to cool.

14.26. Weigh the TDF residue.

- 14.26.1. Remove one SDF filter bag from the desiccant pouch.
- 14.26.2. Roll or fold the bag, place it in a tared Bag Weigh Holder (BWH), and place the BWH in the center of a balance.
- 14.26.3. Record the weight of the filter bag.
- 14.26.4. Repeat steps 25.1 – 25.3 for each SDF filter bag used in the fiber analysis.

14.27. Determine the Protein content within the TDF residue.

See the "Protein Determination" section of this manual for recommended procedures.

14.28. Determine the Ash content within the TDF residue.

See the "Ash Determination" section of this manual for recommended procedures.

14.29. Calculate the % TDF value.

% TDF	=	$\left[\frac{[(R_1 + R_2)/2] - P - A - B}{(M_1 + M_2)/2} \right] \times 100$	
		$= \left[\frac{[(f_{F1} - f_{S1} - D_1) + (f_{F2} - f_{S2} - D_2)]/2 - P_1 - (A_2 - D_2) - B}{(M_1 + M_2)/2} \right] \times 100$	
Where:	M ₁ , M ₂	= Original wt of duplicate samples adjusted for pre-treatment fat and sugar losses (g)	
	R ₁ , R ₂	= Residue for duplicate samples (g)	
	f _F	= Final Filter Bag with residue (g)	
	f _S	= Initial Filter Bag (g)	
	D	= Original wt of Diatomaceous Earth (g)	
	P	= Protein of residue and bag (g)	
	A	= Ash of residue and bag (g)	
	B	= Blank (g)	
		= [(BR ₁ + BR ₂)/2] - P _B - (A _B - D _B)	
		= [(f _{BF1} - f _{BS1} - D _{B1}) + (f _{BF2} - f _{BS2} - D _{B2})]/2 - P _{B1} - (A _{B2} - D _{B2})	
	BR ₁ , BR ₂	= Residue for duplicate blanks (g)	
	f _{BF}	= Final Blank Filter Bag (g)	
	f _{BS}	= Initial Blank Filter Bag (g)	
	P _B	= Protein of Blank Filter Bag (g)	
	A _B	= Ash of Blank Filter Bag (g)	
	D _B	= Original wt of Diatomaceous Earth in Blank Filter Bag (g)	

This page intentionally left blank

15. TDF Analysis (AOAC 985.29 / 2001.03)

A TDF analysis directly measures the amount of TDF within a given sample without separately measuring the IDF and SDF fractions. TDF can be determined using multiple methods. This section describes the procedure for using the ANKOM^{TDF} Dietary Fiber Analyzer to determine TDF based on the AOAC 985.29 and 2001.03 methods.

This analysis requires an SDF filter bag (ANKOM DF-S) for the precipitation process and a non-filter IDF *Flow-Thru* bag (ANKOM DF-FT) for the digestion process. When starting a new run, the ANKOM^{TDF} Dietary Fiber Analyzer must have bags installed at all stations (a total of twelve bags).

NOTE: To enhance the productivity of your instrument, you can begin the IDF process of a new run while the SDF process of a previous run is finishing. See the "Productivity Enhancement" section of this manual for more details.

To perform a TDF analysis, follow the steps below.

15.1. Prepare chemicals and enzymes.

When using the ANKOM^{TDF} Dietary Fiber Analyzer for the AOAC 985.29 or 2001.03 methods use the chemicals and enzymes referred to therein. See Appendix A of this manual for the list of chemicals and enzymes and the instructions for how to prepare them for use in this instrument.

15.2. For samples that have a fat content of 10% or higher, de-fat your samples as needed according to the official methods or internal SOPs.

15.3. Label the bags using a Solvent Resistant Marker.

IDF *Flow-thru* Bag
(shorter bag / no filter)



SDF Bag (longer bag with filter)

15.4. Prepare for data collection.

You will need a place to store the data collected during this analysis. For your convenience, a USB flash drive was included with the instrument. This USB includes a Calculation Template MS-Excel file that can be used for this analysis. Please read the "Instructions" tab in the Calculation Template MS-Excel file for information about the spreadsheets.

15.5. Weigh filter bags.

IMPORTANT: Using a Bag Weigh Holder is critical to eliminate the effects of static electricity during the weighing process.

Roll or fold each bag and place it in a tared Bag Weigh Holder. Place the Bag Weigh Holder in the center of a balance and record the weight.



NOTE: Because different balances have different sensitivities, the Bag Weigh Holder should be placed in the center of the balance for best results.

15.6. Weigh Diatomaceous Earth (DE).

DE is used during fiber analysis to enhance the flocculation and filtration of the SDF fraction. Place approximately 1 g of DE in each of six tared and numbered tins/weigh boats and record the weights.

15.7. Weigh Samples.

Place 0.5±0.05 g of sample in each of six tared and numbered tins/weigh boats and record the weights.

NOTE: A larger sample (1.0 g) can be used if a larger aliquot is needed to improve precision.

15.8. Turn the instrument power on.

When you turn the power on, the instrument will run through an initialization process and the Control Panel will turn on.

15.9. Confirm Nitrogen Supply and pressure ranges.

Make sure the Nitrogen supply in your lab is connected to the instrument and turned on. The High Pressure Gauge on the left of the instrument should be set between 50-55 psi. The Low Pressure Gauge on the right side of the instrument should be set at 4 psi. The accuracy of the Low Pressure Gauge should be checked prior to each run by pressing the "Pressurize SDF" button on the control panel twice.

High Pressure Gauge
50-55 psi (3.5-3.8 bar)



Low Pressure Gauge
4 psi (0.3 bar)



15.10. On the Touch Screen Display, select the instrument function you would like to perform.

The Control Panel on the ANKOM^{TDF} Dietary Fiber Analyzer uses Touch Screen technology. To operate the instrument you will press identified buttons on the Touch Screen Display and buttons below the screen.

When your instrument is initialized and ready to operate, the following screen will be displayed.

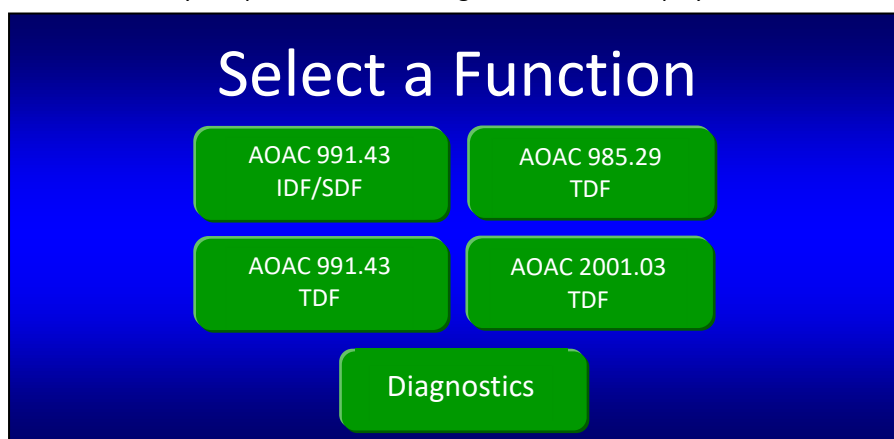

NOTE: Although the instrument works in accordance with AACC and NMKL methods, the Touch Screen Display only refers to the AOAC methods.

To avoid a Vacuum Sensor Fault, the lines must be charged if: this is the first time the instrument is being operated after being installed, if the instrument has sat unused for a period of time (and was flushed according to Appendix C), or if this is the first time used after tubing was replaced.

To charge the lines, attach the Flush Tubing Assembly and connect it to the Water Container filled with DI or DW water, then follow the steps below.

15.10.1. Press the **Diagnostics** button on the "Select a Function" screen. The following screen will be displayed.

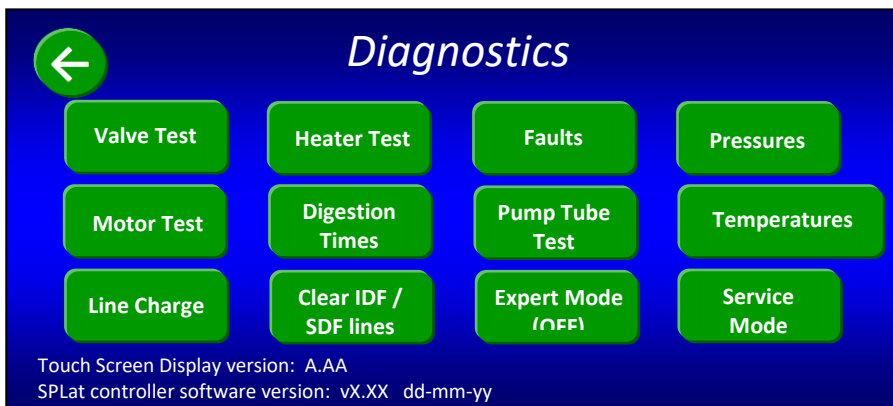

15.10.2. Press the **Line Charge** button. The following screen will be displayed.

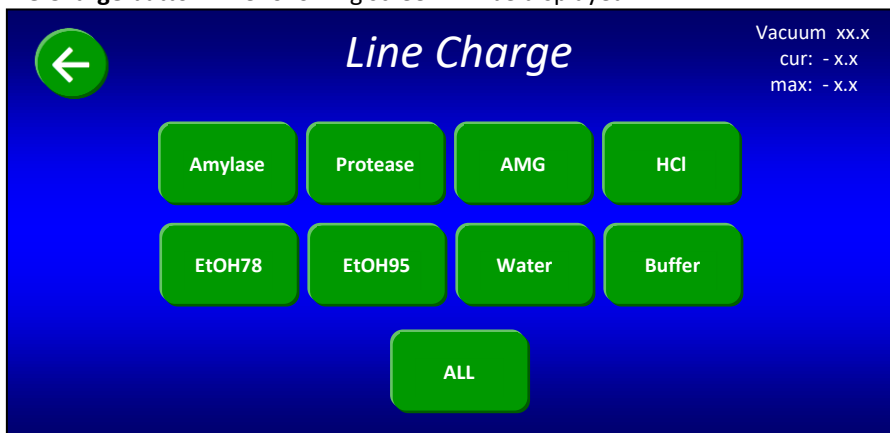

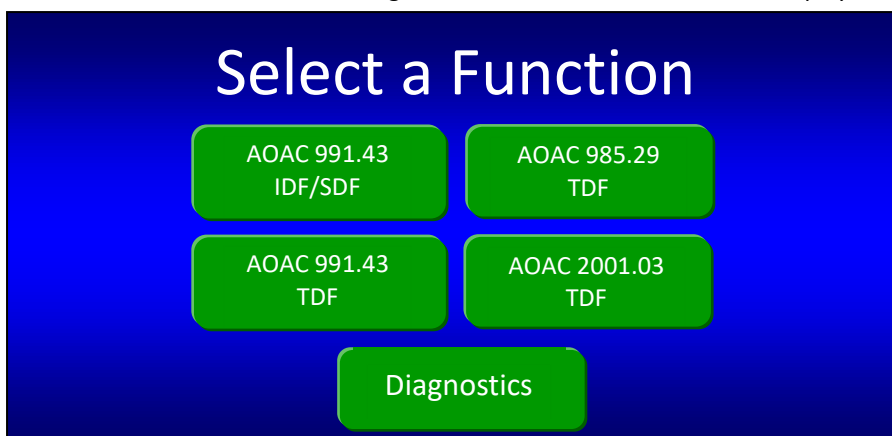

15.10.3. Press the ALL button to charge all of the lines. Each button will change color as the associated line is being charged. All lines are charged when all of the buttons return to their original green color.

15.10.4. Press the back  button twice. The following "Select a Function" screen will be displayed again.

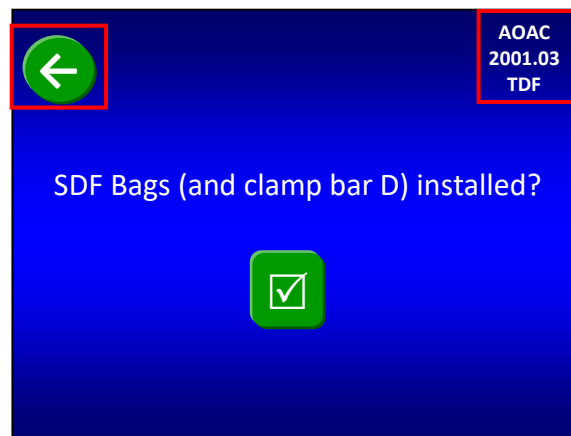
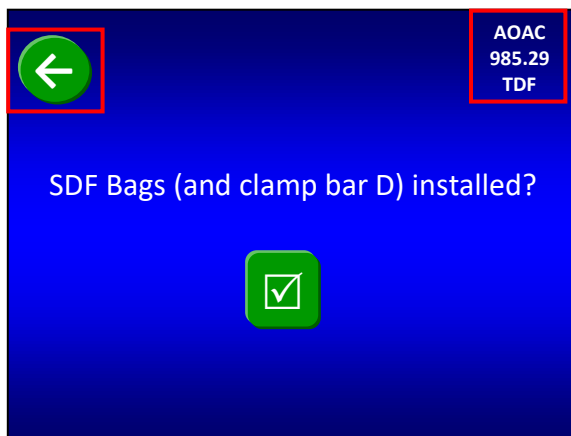

15.10.5. Press either the **AOAC 985.29 TDF** button or the **AOAC 2001.03 TDF** button depending on the method you're doing. One of the following screens will be displayed.



Notice that the function you selected is now displayed in the top right corner of the screen and a back  button is displayed in the top left corner of the screen.

15.11. Install SDF filter bags on the ANKOM^{TDF} Dietary Fiber Analyzer.

15.11.1. Remove Clamp Bars A, B, C, and D by lifting them off of the locator rods.

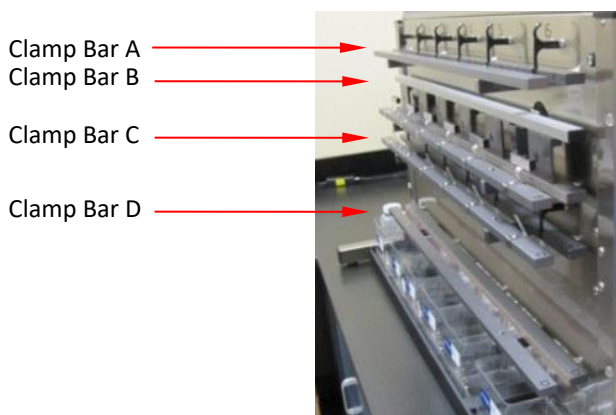

15.11.2. Gently pull the black SDF Delivery Nozzle out toward you.



- 15.11.3. Place a labeled and weighed SDF bag up underneath the SDF Delivery Nozzle so that the Delivery Nozzle is inside the top part of the bag. Pull the bag up so that the top of the bag is about 35 mm (1.375 inches) above the top of Clamp Bar C and return the Delivery Nozzle to its original position. This will hold the back of the bag in place.



IMPORTANT:

As part of normal operation, solution from the IDF *Flow-thru* bag will flow into the SDF bag. Therefore, when installing the SDF filter bags it is very important to position them high enough vertically so that at least 20 mm (0.75 inches) of the bottom of the IDF *Flow-thru* bag can fit inside the top of the SDF bag.

- 15.11.4. With the bag being held by the Delivery Nozzle, center it horizontally between the lines on the back part of Clamp Bar C.

Centering Lines



- 15.11.5. Repeat previous steps for all six stations.
 15.11.6. Re-install Clamp Bar D by setting it on the locator rods. Make sure the letter is on the top of the bar and the rubber material is facing in toward the instrument.
 15.11.7. Flatten the bags to remove any wrinkles.
 15.11.8. With fingers away from the clamp bars, press the check mark (☑) button on the Touch Screen Display to pinch the bags. One of the following screens will be displayed.

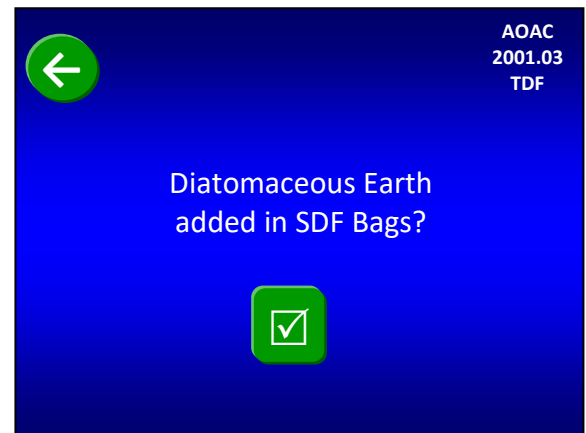
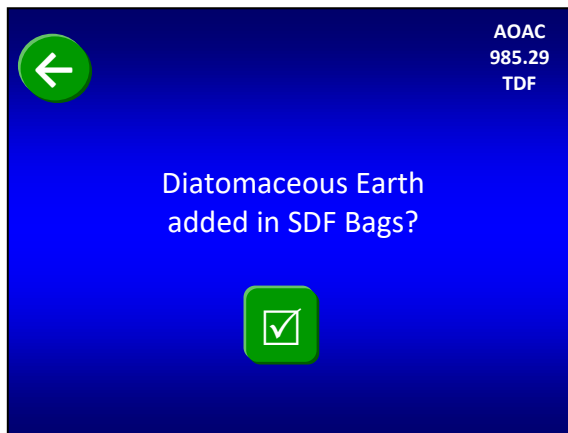

15.12. Add DE to the SDF filter bags on the ANKOM^{TDF} Dietary Fiber Analyzer.

- 15.12.1. Open the top of the SDF bag and add a weigh tin of DE to the bag by folding the tin and then dipping it down into the bag below the tip of the Delivery Nozzle.



IMPORTANT: When adding DE to the filter bags it is very important to keep it below the tip of the Delivery Nozzle so that the DE material can be properly rinsed.

- 15.12.2. Rinse the tin with no more than 3 ml of 78% EtOH to ensure complete transfer.
 15.12.3. Repeat previous steps for all six stations.
 15.12.4. Press the check mark (☑) button on the Touch Screen Display. One of the following screens will be displayed.

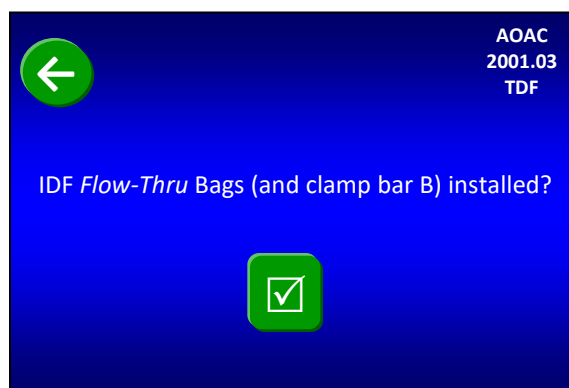
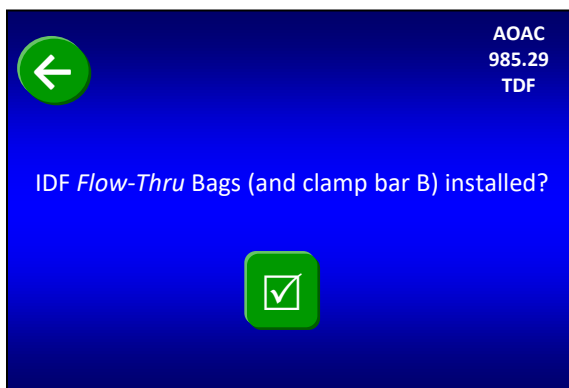

NOTE: After you confirm that the DE is added, the Clamp Bar D button on the Control Panel is disabled until the SDF process completes.

15.13. Install IDF *Flow-thru* bags on the ANKOM^{TDF} Dietary Fiber Analyzer.

- 15.13.1. Gently pull the black IDF Delivery Nozzle out toward you.



- 15.13.2. Place a labeled IDF Flow-Thru bag up underneath the Delivery Nozzle so that the Delivery Nozzle is inside the top part of the bag. Pull the bag up so that the top of the bag is about 35 mm (1.375 inches) above the top of Clamp Bar A and return the Delivery Nozzle to its original position. This will hold the back of the bag in place.

15.13.3. With the bag held by the Delivery Nozzle, center it horizontally between the Centering Lines on the back part of Clamp Bar A.

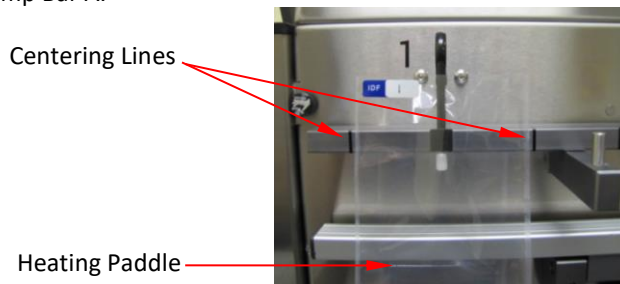

IMPORTANT: For proper mixing during the IDF process the IDF *Flow-thru* bags must be horizontally centered over the Heating Paddles and between the Centering Lines on the back part of Clamp Bar A.

15.13.4. Place at least 20 mm (0.75 inches) of the bottom of the IDF *Flow-Thru* bag inside the top of the SDF bag to allow for the flow of solution into the SDF bag after the digestion process is complete.

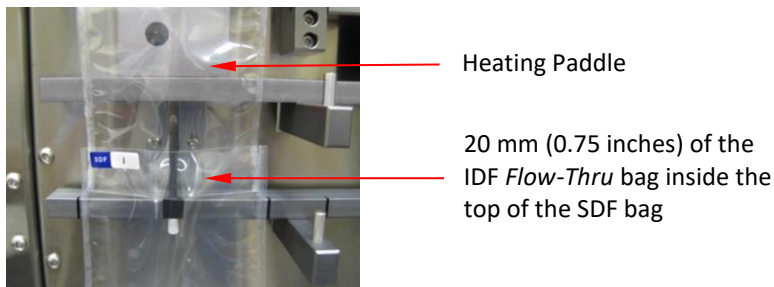

- 15.13.5. Repeat previous steps for all six stations.
- 15.13.6. Re-install Clamp Bar B by setting it on the locator rods. Make sure the letter is on the top of the bar and the rubber material is facing in toward the instrument.
- 15.13.7. Flatten the IDF *Flow-Thru* bags to remove any wrinkles.
- 15.13.8. With fingers away from the clamp bars, press the check mark (☑) button on the Touch Screen Display to pinch the IDF *Flow-Thru* bags. The mixing pads will make contact with the bags when Clamp Bar B pinches the IDF *Flow-Thru* bags. One of the following screens will be displayed.

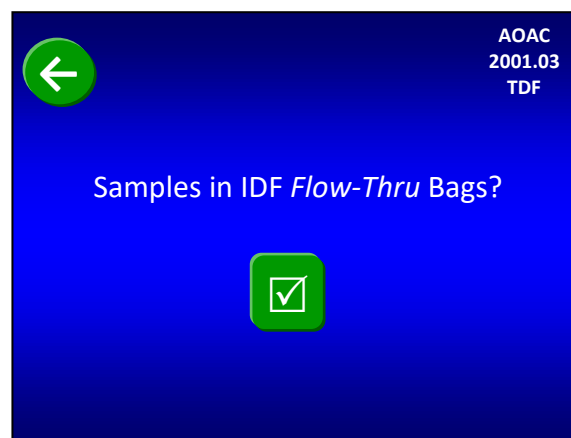
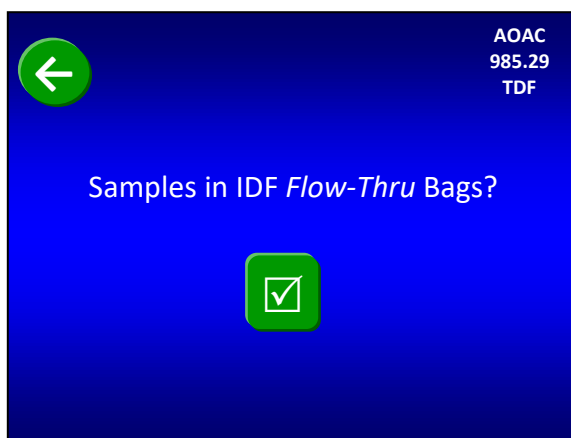

15.14. Add samples to the IDF *Flow-thru* bags.

15.14.1. Open the top of the IDF *Flow-thru* bag and transfer the sample from a weigh tin into the bag by folding the tin and then dipping it down into the bag below the tip of the Delivery Nozzle.



IMPORTANT: When adding sample to the IDF *Flow-thru* bags it is very important to keep it below the tip of the Delivery Nozzle so that it can be properly rinsed.

15.14.2. Rinse the tin with no more than 3 ml of DI or DW Water to ensure complete transfer.

15.14.3. Repeat previous steps for all IDF stations.

15.14.4. Re-install Clamp Bar A by setting it on the locator rods. Make sure the letter is on the top of the bar and the rubber material is facing in toward the instrument.

15.14.5. Press the check mark (☑) button on the Touch Screen Display. One of the following screens will be displayed.

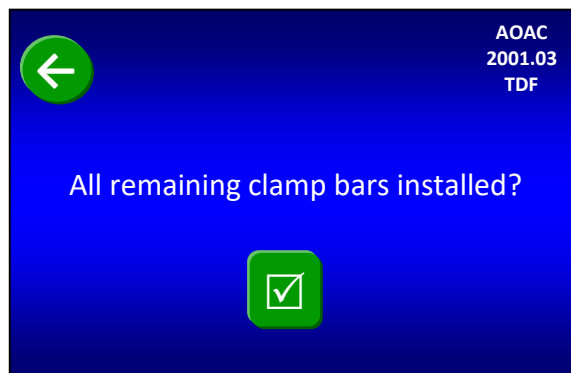
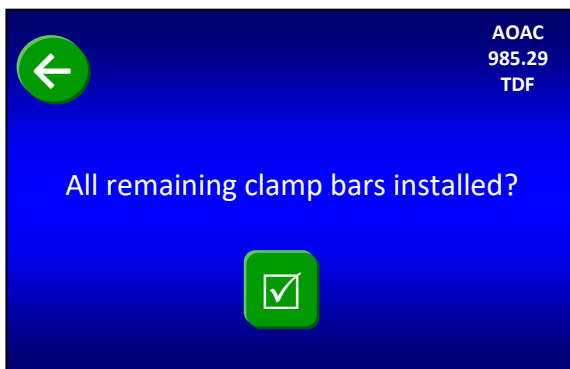

15.14.6. Make sure that all clamp bars are installed with the letter on the top of the bar and the rubber material facing in toward the instrument. Press the check mark (☑) button on the Touch Screen Display. One of the following screens will be displayed.

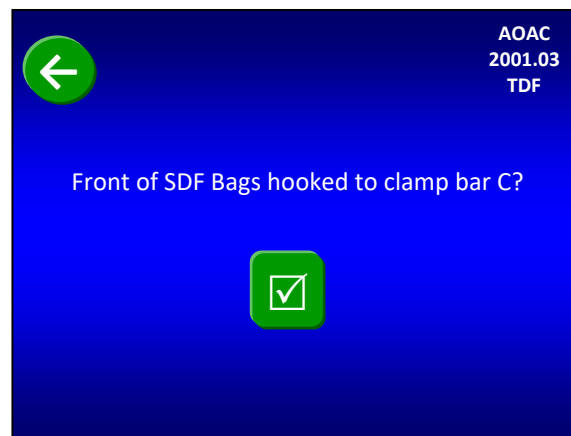
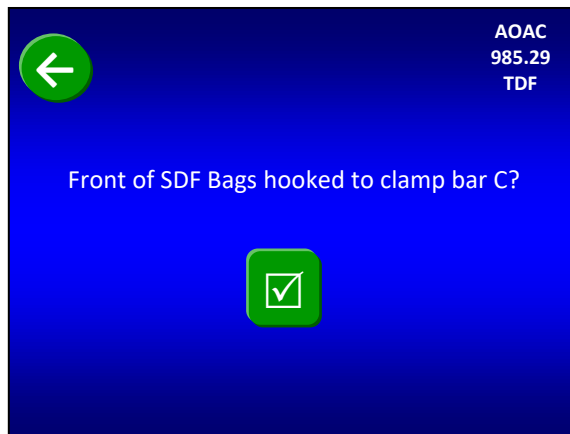

15.15. Hook the front of each SDF bag in place.

15.15.1. Secure the SDF filter bags in place with the hooks located on the front part of Clamp Bar C.



Hook on front part of
Clamp Bar C

NOTE: Hooking the bags in place will put a physical hole in the front of each SDF bag.

15.15.2. Press the check mark (☑) button on the Touch Screen Display. If you ran a method other than 985.29 or 2001.03 prior to this run, one of the following screens will be displayed.

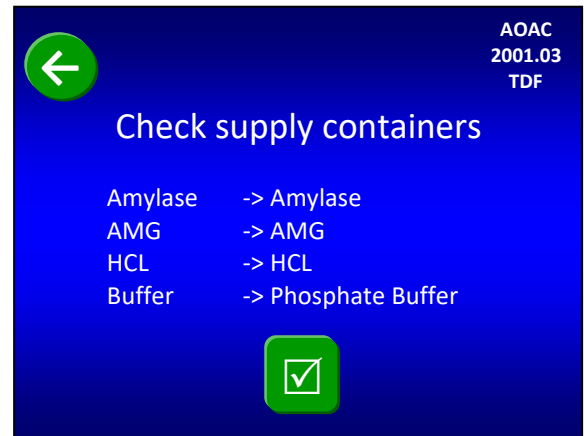
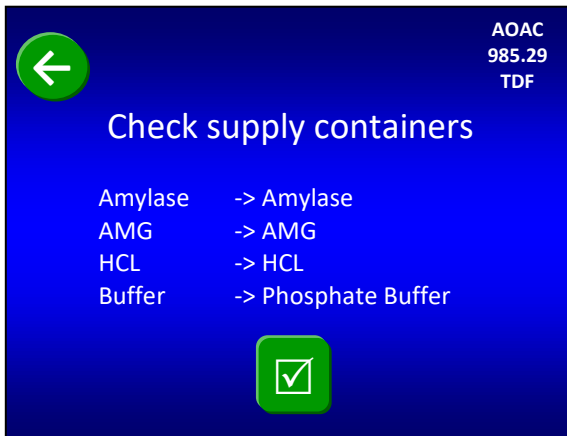

15.16. Verify that the fluid containers have the correct fluids for this procedure.

Verify that the fluid supply containers are configured according to the screen above and press the check mark (☑) button. One of the following screens will be displayed.

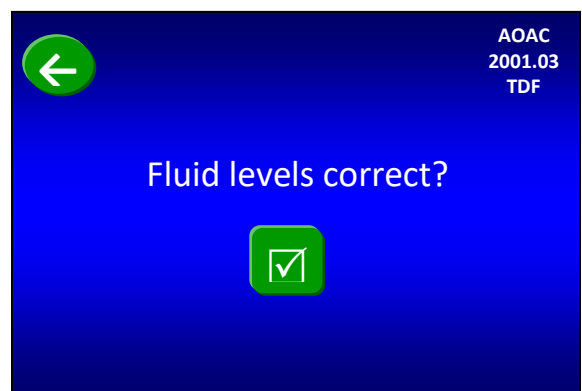
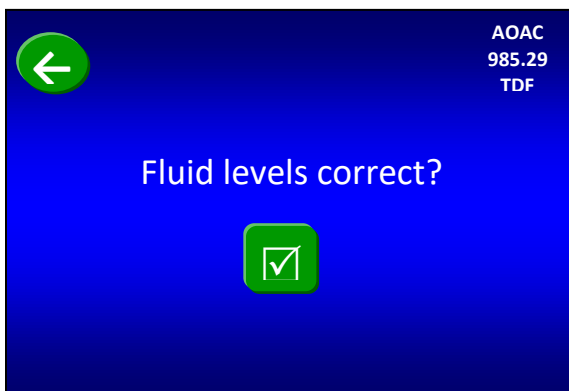

15.17. Fill fluid containers.

To ensure that you have enough fluids to run a complete TDF procedure, you must begin with fluid levels above the Minimum Level lines on the chemical containers and at least 15 ml of each enzyme. Add fluids and enzymes as necessary.

IMPORTANT: Do NOT leave the enzyme ports on the instrument open to the air or the enzymes in the valves may dry up and plug the ports.

With all fluid containers filled to the proper levels, press the check mark (☑) button on the Touch Screen Display. One of the following screens will be displayed.



15.18. Confirm Nitrogen Supply ON.

Confirm the high-pressure gauge on the left of the instrument shows 50-55 psi. The low-pressure gauge on the right side of the instrument should be set at 4 psi.

Press the check mark (☑) button on the Touch Screen Display. One of the following screens will be displayed.

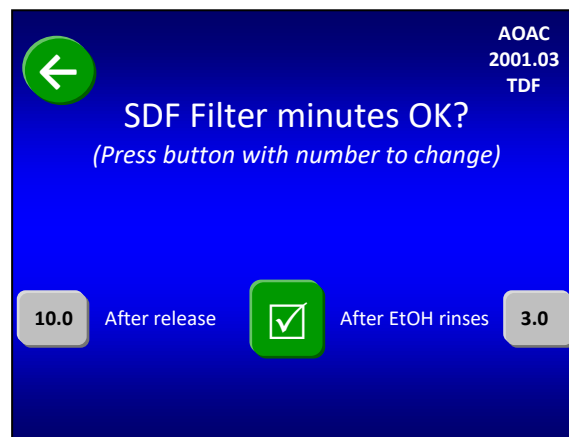
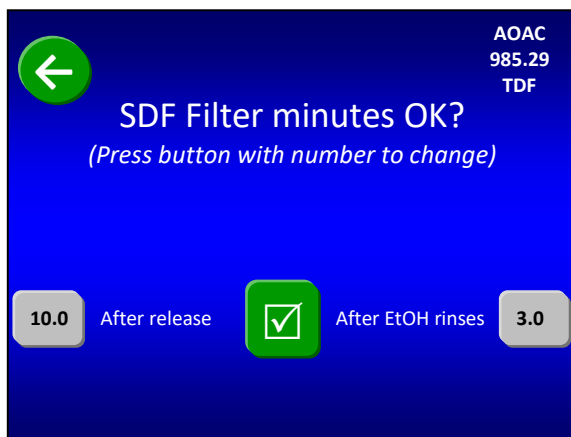

15.19. Set filter times (in minutes).

Because different samples take different amounts of time to filter, the above screen allows you to set your filter times. To change any of the times shown on the screen, press the specific gray button. A number pad will be displayed that will allow you to enter the time that you want. The times you enter will remain until you change them again.

NOTE:

The initial filter times shown when you first run the instrument are based on factory experience. During filtration the computer allows you to bypass the filter time if you notice the filtering is complete. The computer also allows you to add time during filtering if needed (see the "Status Screen" section of this manual for more detail).

When all of the times shown on the screen are what you want, press the check mark (☑) button on the Touch Screen Display. One of the following screens will be displayed.

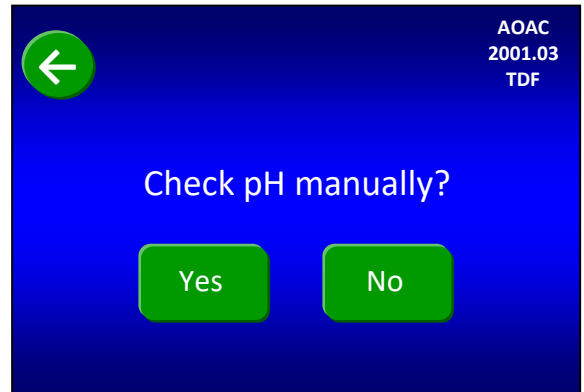
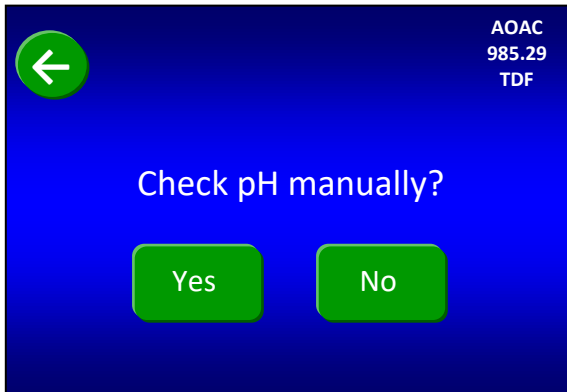

15.20. Set the manual pH check for after the Protease digestion.

When running the AOAC 985.29 method or the AOAC 2001.03 method, the instrument will always stop just before the Protease digestion (after the bags have cooled to the appropriate temperature) and ask you to adjust pH.

If you plan to also check/adjust the pH after the Protease digestion, press the **Yes** button on the screen above. Otherwise, press the **No** button. One of the following screens will be displayed.

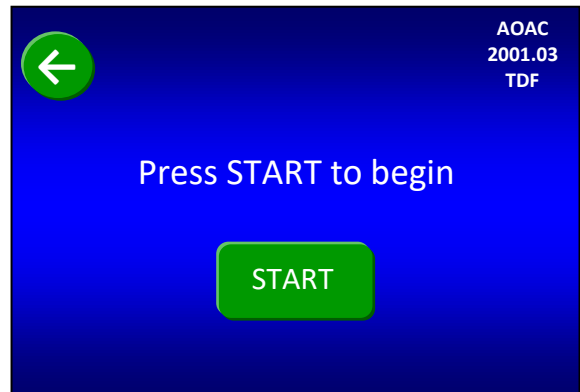
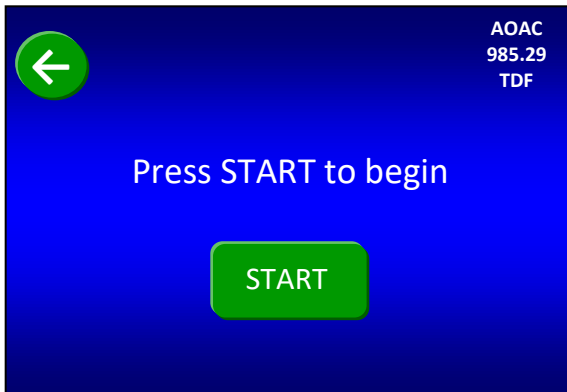

15.21. Start the instrument.

The instrument is now completely set up to run a TDF procedure. Press the **START** button to begin. At the beginning of each new run, the instrument automatically runs a tube integrity test.

AOAC 985.29 calls for a pH check after the buffer step. Once the buffer had been added, the user can manually check and adjust pH to 6.0 ± 0.2 by doing the following:

- Open clamp bar A (manually press green button below touch screen).
- Measure and adjust pH using a probe that can easily be rinsed (with DI or DW water). If you add acid or base to adjust the pH, you must mix the solution to get an accurate pH reading. Manually mix the solution by pressing the outside of the bag, with your fingers, just above clamp bar B multiple times.
- Close clamp bar A.

For the first run after a power-up cycle, or for the first run after the instrument has been idle for twelve hours, the following screen will be displayed.

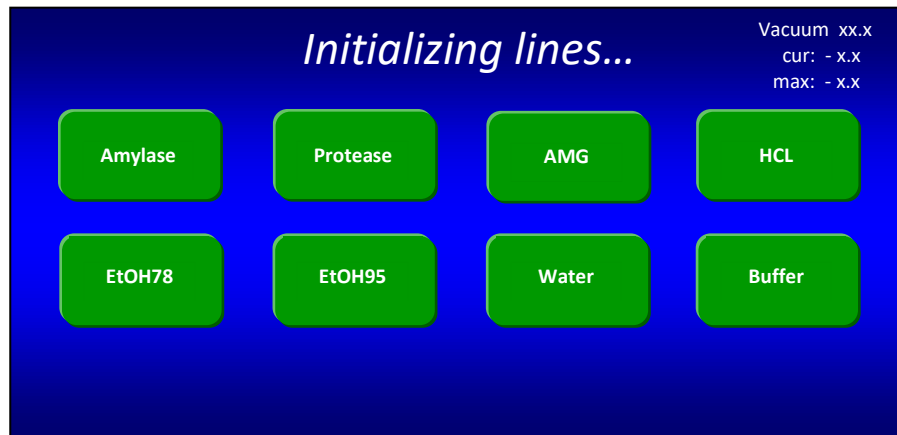

If the fluid lines are already charged properly, or when the line charge is complete, the following screen will be displayed.

When the tube integrity check is complete, the instrument will automatically execute the TDF procedure stopping only for faults, aborts, and manual pH adjustment. The Status screen will show actions and faults as they occur during the automatic operation.

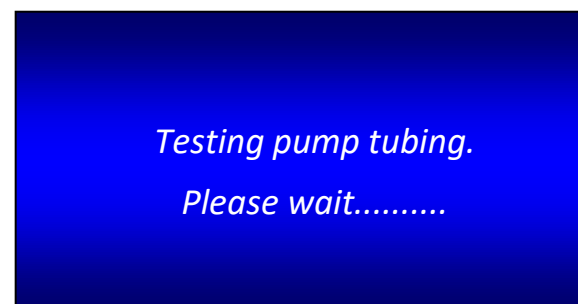

15.22. Adjust pH before the Protease digestion.

Just before the Protease digestion (after the bags have cooled) the instrument will stop, open Clamp Bar A, display the screen below, and make a sound to remind you to manually adjust pH.

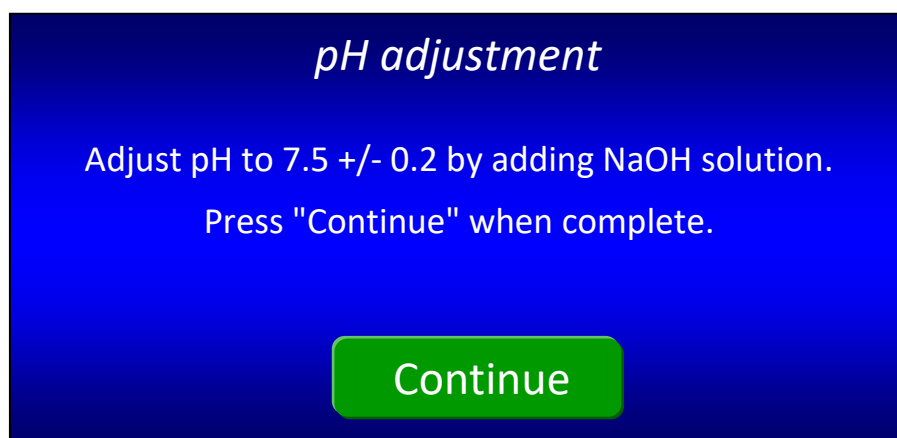

When measuring/adjusting pH use a probe that can be easily rinsed (with DI or DW Water) to avoid loss of sample. If you add acid or base to adjust the pH, you must mix the solution in order to get an accurate pH reading. To manually mix the solution, press the outside of the bag with your fingers just above Clamp Bar B multiple times.



After adjusting the pH, press the **Continue** button.

15.23. Manually measure/adjust pH after the Protease digestion.

One of the questions you are asked before starting the automated procedure is: "Check pH manually?" If you answered "Yes" to this question, the instrument will stop after adding the required HCl, open Clamp Bar A, display one of the screens below, and make a sound to remind you to manually measure pH and adjust to 4.0 - 4.6 if necessary.

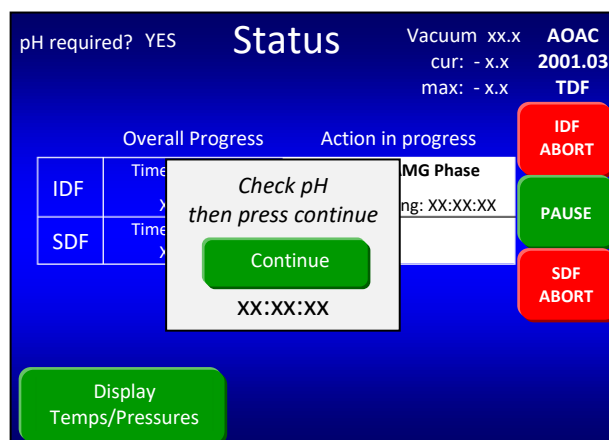
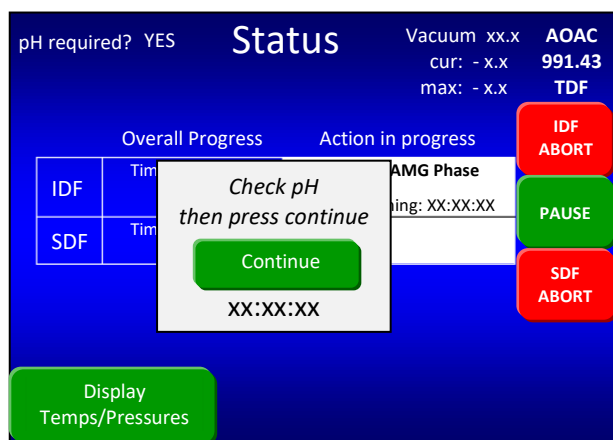

When you have completed the pH measurement process, press the **Continue** button on the Status screen. You will see "COMPLETE" next to "pH required?" in the upper left corner of the screen.

15.24. Make sure that each sample is completely rinsed down into the SDF filter bags (as needed).

Since the IDF *Flow-thru* bags are not weighed before and after the process, it is important to make sure that each sample gets rinsed down into the SDF filter bag when the digestion process is complete. This is especially important for sticky samples.

If you notice sample sticking to an IDF *Flow-thru* bag, use 78% EtOH in a wash bottle to rinse as needed.

15.25. Rinse the SDF filter bags with acetone.

After the instrument has completed a TDF process the TDF residue that has been collected in the SDF bag must be manually rinsed with acetone. It is recommended that you use an ANKOM TDF51 Rinse Stand (sold separately) for rinsing filter bags with acetone.

To rinse the SDF filter bags with acetone using the ANKOM TDF51 Rinse Stand, follow the steps below.

- 15.25.1. Remove the SDF bags from the instrument.
- 15.25.2. Place the bags on the Rinse Stand by sliding the back part of the bag under the pinch mechanism. Keep the top of the bag open.



- 15.25.3. Using a wash bottle, squirt acetone completely around the inside polypropylene surfaces of each bag two times, making sure that all residue on the surfaces is rinsed down into the filter.
- 15.25.4. Repeat previous step so that each bag gets rinsed a total of two times. After the two full rinses, target any sample still clinging to the walls of the bag with Acetone making sure all of the sample is pushed into the filter part of the bag.
- 15.25.5. Allow acetone to evaporate from the bags for 30-40 minutes.



Hazardous Materials – Do NOT heat seal or place bags in an oven until all acetone has evaporated.

- 15.25.6. With your Heat Sealer (HS/HSi) set between 3 and 4 (settings may vary depending on the heat sealer and the power source), press the Heat Sealer arm down. Hold the arm down for 3 to 4 seconds after the light goes out to seal each bag just above the filter. This keeps all residue contained to the filter area while handling the bags.



- 15.25.7. Place each bag in the Drying Rack.



15.26. Dry the SDF filter bags.

- 15.26.1. Make sure your oven is 105°C at the location where the bags will be placed.
- 15.26.2. Place the Drying Rack with the filter bags in the oven and dry to constant weight (a minimum of 90 minutes).
- 15.26.3. When dry, remove all SDF filter bags from the oven and place them in a desiccant pouch to cool.

15.27. Weigh the TDF residue.

- 15.27.1. Remove one SDF filter bag from the desiccant pouch.
- 15.27.2. Roll or fold the bag, place it in a tared Bag Weigh Holder (BWH), and place the BWH in the center of a balance.
- 15.27.3. Record the weight of the filter bag.
- 15.27.4. Repeat previous steps for each SDF filter bag used in the fiber analysis.

15.28. Determine the Protein content within the TDF residue.

See the "Protein Determination" section of this manual for recommended procedures.

15.29. Determine the Ash content within the TDF residue.

See the "Ash Determination" section of this manual for recommended procedures.

15.30. Calculate the % TDF value.

% TDF	=	$\left[\frac{[(R_1 + R_2)/2] - P - A - B}{(M_1 + M_2)/2} \right] \times 100$	
		$= \left[\frac{[(f_{F1} - f_{S1} - D_1) + (f_{F2} - f_{S2} - D_2)]/2 - P_1 - (A_2 - D_2) - B}{(M_1 + M_2)/2} \right] \times 100$	
Where:	M₁, M₂	= Original wt of duplicate samples adjusted for pre-treatment fat and sugar losses (g)	
	R₁, R₂	= Residue for duplicate samples (g)	
	f_F	= Final Filter Bag with residue (g)	
	f_S	= Initial Filter Bag (g)	
	D	= Original wt of Diatomaceous Earth (g)	
	P	= Protein of residue and bag (g)	
	A	= Ash of residue and bag (g)	
	B	= Blank (g)	
		= $[(BR_1 + BR_2)/2] - P_B - (A_B - D_B)$	
		= $[(f_{BF1} - f_{BS1} - D_{B1}) + (f_{BF2} - f_{BS2} - D_{B2})]/2 - P_{B1} - (A_{B2} - D_{B2})$	
	BR₁, BR₂	= Residue for duplicate blanks (g)	
	f_{BF}	= Final Blank Filter Bag (g)	
	f_{BS}	= Initial Blank Filter Bag (g)	
	P_B	= Protein of Blank Filter Bag (g)	
	A_B	= Ash of Blank Filter Bag (g)	
	D_B	= Original wt of Diatomaceous Earth in Blank Filter Bag (g)	

16. Protein Determination

NOTE:

AOAC methods 991.43, 985.29, and 2001.03 suggest that the Kjeldahl method be used for determining protein content. Since a large amount of acid is used in the Kjeldahl digestion process, make sure you use enough base in the Kjeldahl distillation process.

16.1. IDF – Kjeldahl Method

To determine the protein content within the IDF residue, follow the procedure below.

- 16.1.1. Cut the filter bag just above the seal.



- 16.1.2. Cut off the polypropylene skirt that covers the filter (both sides) being careful to keep the filter sealed and intact. This minimizes the acid needed to digest the filter bag during the Kjeldahl procedure.



- 16.1.3. Fold the remainder of the filter bag in thirds from side to side; then fold from top to bottom.

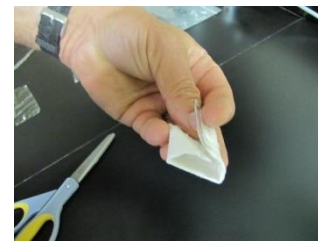
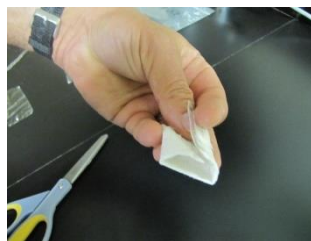

- 16.1.4. With your Heat Sealer set to "6" (setting may vary depending on heat sealer and power source), place the exposed polypropylene material from your final fold down, and press the Heat Sealer arm down for 3 to 4 seconds to seal each bag. Repeat if necessary.

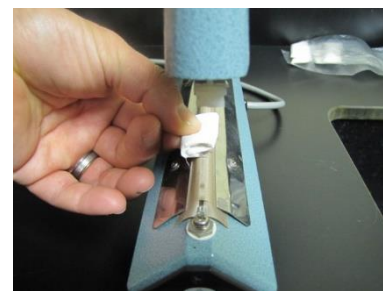

- 16.1.5. Label the folded, sealed filter bag.

- 16.1.6. Repeat previous steps for all IDF bags that will be used for determining protein content.

- 16.1.7. Run a Kjeldahl procedure on each filter bag using 17 ml of H_2SO_4 , 10 g of K_2SO_4 , and 300 mg of $CuSO_4 \cdot 5H_2O$ in a system with 250 ml tubes that have a 42 mm diameter. Pellets can be used if an equivalent amount of K_2SO_4 is added. To slow down the rate of foaming during the digestion process, ramp up the temperature in the following way: 15 minutes at 150°C followed by 15 minutes at 250°C followed by 15 minutes at 350°C and finally 40 minutes at 420°C.

16.2. SDF / TDF – Kjeldahl Method

To determine the protein content within the SDF or TDF residue, follow the procedure below.

16.2.1. Cut the filter bag 8 -10 mm above the filter.



16.2.2. Fold the remainder of the filter bag in thirds from side to side.



16.2.3. With your Heat Sealer set to “6” (setting may vary depending on heat sealer and power source), press the arm down for 3 to 4 seconds to seal the polypropylene edge of the filter bag. Repeat if necessary.



16.2.4. Label the folded, sealed filter.

16.2.5. Repeat previous steps for all SDF bags that will be used for determining protein content.

16.2.6. Run a Kjeldahl procedure on each filter bag using 27 ml of H₂SO₄, 10 g of K₂SO₄, and 300 mg of CuSO₄·5H₂O in a system with 250 ml tubes that have a 42 mm diameter. Pellets can be used if an equivalent amount of K₂SO₄ is added. To slow down the rate of foaming during the digestion process, ramp up the temperature in the following way: 15 minutes at 150°C followed by 15 minutes at 250°C followed by 15 minutes at 350°C and finally 40 minutes at 420°C.

17. Ash Determination

IMPORTANT:

ANKOM Technology recommends that you use ceramic crucibles with fitted covers to avoid cross contamination or loss of ash. Fold the filter bags so that they easily fit into the crucibles.

17.1. IDF

To determine the ash content within the IDF residue, follow the procedure below.

- 17.1.1. Starting at the bottom of the filter part of the bag, fold the bag upward, leaving at least 10 mm at the top of the clear polypropylene that is not folded. Then fold the bag in thirds from side to side.

10 mm of clear
polypropylene

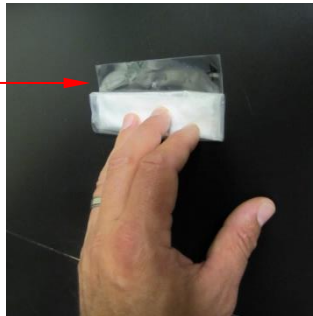

- 17.1.2. With your Heat Sealer set to "6" (setting may vary depending on heat sealer and power source), press the Heat Sealer arm down for 3 to 4 seconds to seal the clear polypropylene part of the bag just above the white filter material.

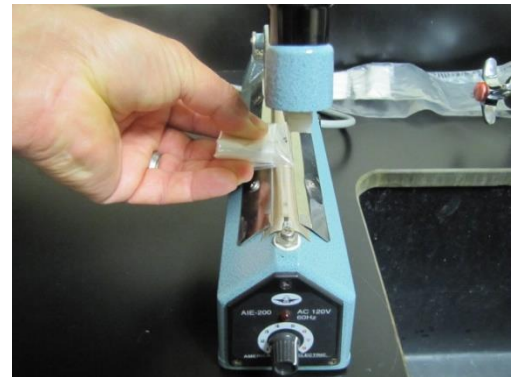

- 17.1.3. Label the folded, sealed filter bag and place it in a labeled ashing crucible.



- 17.1.4. Repeat previous steps for all IDF bags to be ashed.
17.1.5. Place covered ashing crucibles with filter bags in a furnace at 600°C for 3 hours.
17.1.6. After the 3 hour furnace time, place the ashed crucibles in desiccator(s) and allow them to cool.
17.1.7. Remove cooled crucibles from the desiccator(s) and record their weights.

17.2. SDF / TDF

NOTE: During a TDF procedure there is no residue captured in the IDF *Flow-Thru* bag. Therefore, the ash procedure is only required for the SDF filter bag.

NOTE: DE used in the precipitation process can sometimes be difficult to fully rinse from the walls of the polypropylene bags. Therefore, ANKOM Technology recommends that the entire SDF bag be ashed.

To determine the ash content within the SDF / TDF residue, follow the procedure below.

- 17.2.1. Starting at the bottom of the filter part of the bag, fold the bag upward, leaving at least 10 mm at the top of the clear polypropylene that is not folded. Then fold the bag in thirds from side to side.

10 mm of clear polypropylene

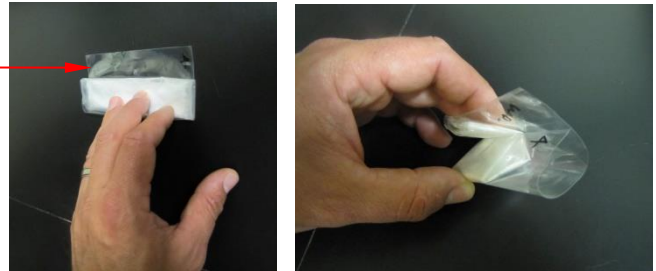

- 17.2.2. Set your Heat Sealer to "6" (setting may vary depending on heat sealer and power source) and press the Heat Sealer arm down for 3 to 4 seconds to seal the unfolded polypropylene to the folded part of the bag.

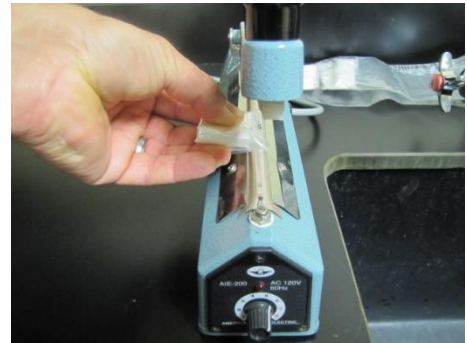

- 17.2.3. Label the folded, sealed filter bag and place it in a labeled ashing crucible.



- 17.2.4. Repeat previous steps for all SDF bags to be ashed.
 17.2.5. Place covered ashing crucibles with filter bags in a furnace at 600°C for 3 hours.
 17.2.6. After the 3 hour furnace time, place the ashed crucibles in desiccator(s) and allow them to cool.
 17.2.7. Remove cooled crucibles from the desiccator(s) and record their weights.

18. Productivity Enhancement

18.1. Start a new procedure while a previous one is in progress.

To enhance the productivity of your instrument, you can begin the digestion process (run in the IDF part of the instrument) of a new procedure (IDF/SDF or TDF) while the precipitation process (run in the SDF part of the instrument) of a previous procedure (IDF/SDF or TDF) is still running.

NOTE: This feature is NOT available if the precipitation time has been extended beyond 60 minutes.

IMPORTANT: When starting a new run, the ANKOM^{TDF} Dietary Fiber Analyzer must have bags installed at all stations (a total of twelve bags). If you are starting a digestion process while a precipitation process is running, you must install IDF or IDF *Flow-Thru* bags at all six IDF stations.

When a digestion process completes, the following screen is displayed showing that the process in the top bags is complete. The Method & Procedure shown in the top right corner will be the one that is currently in progress in the bottom bags.

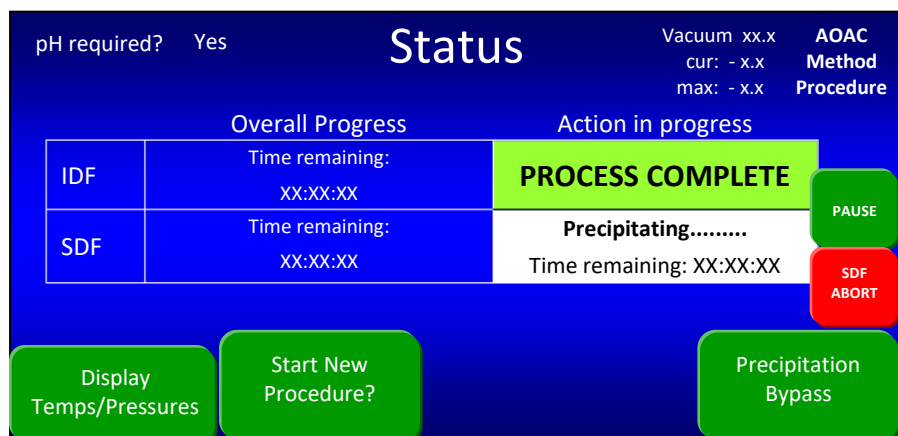

At this time you can remove the IDF or IDF *Flow-Thru* bags from the instrument; then press the **Start New Procedure** button on the screen. The following screen will be displayed.

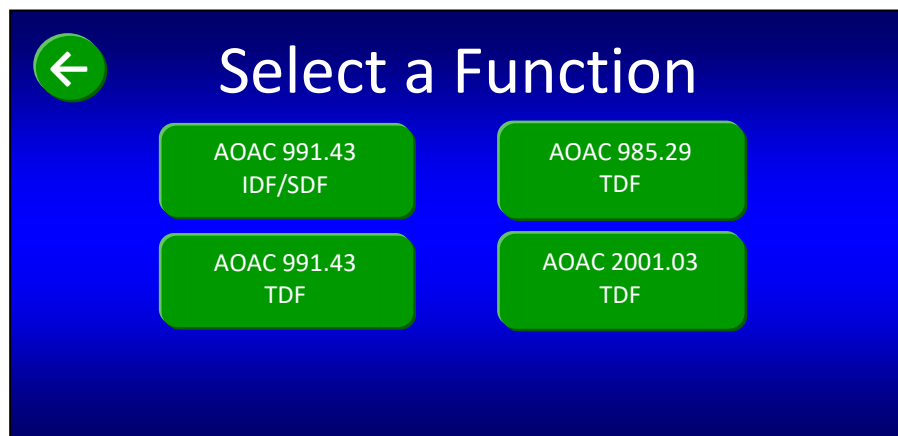

To start a new assay immediately after an IDF process completes, follow the steps below.

18.1.1. Prepare samples and configure the instrument for a new digestion.

Refer to the IDF/SDF Analysis and TDF Analysis sections of this manual, following all steps except for those that deal with the precipitation process (SDF). This will include interaction with the Touch Screen Display to verify the instrument set-up (as shown in the IDF/SDF Analysis and TDF Analysis sections).

IMPORTANT: Because an SDF process from the previous run is still in progress, you can leave the bottom of the IDF or IDF *Flow-Thru* bags outside of the SDF bags for now. However, you must **REMEMBER** to place the bottom of the IDF or IDF *Flow-Thru* bags in the top of the SDF bags after new SDF bags are installed.

After you confirm your set-up, the following screen is displayed. The Method & Procedure shown in the top right corner will be the one that you just started in the top bags.

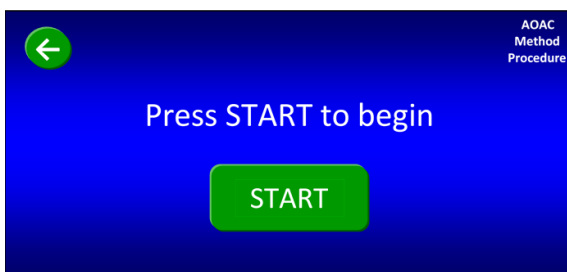

18.1.2. Perform the digestion process using the ANKOM^{TDF} Dietary Fiber Analyzer.

To perform the new digestion process, press the **START** button to begin. The following screen will be displayed.

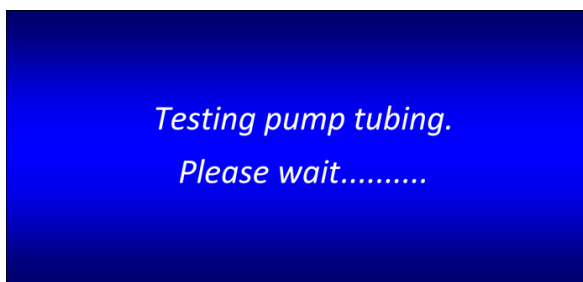

After the pump tube testing is complete, the Status screen will be displayed.

NOTE: The procedure shown in the top right corner of the Status screen reflects the procedure that was most recently started. Therefore, if you ran an IDF/SDF procedure, and then started a TDF procedure before the precipitation process for the previous IDF/SDF procedure completed, the top right corner of the display will show "TDF" even though the IDF/SDF procedure is not fully complete.
The material from the IDF or IDF *Flow-Thru* bags will not empty into the SDF bags until you verify that new SDF bags have been installed.

18.1.3. Install new SDF bags on the ANKOM^{TDF} Dietary Fiber Analyzer and continue the run.

When an SDF process completes while an IDF process is in progress, the following screen is displayed. The Method & Procedure shown in the top right corner is the one that is running in the top bags.

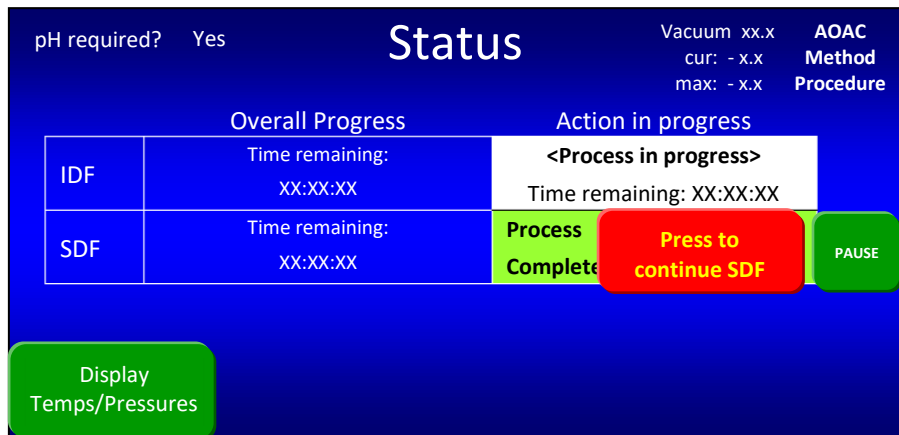

In the "Action in progress" box for the SDF process you will see a **Press to continue SDF** button. Press that button and follow the instructions on the Touch Screen Display.

IMPORTANT: Remember to place the bottom of the IDF or IDF *Flow-thru* bags in the top of the SDF bags when installing the new SDF bags.

After you confirm your set-up, the following Status screen is displayed. The Method & Procedure shown in the top right corner is the one that is running in the top bags.

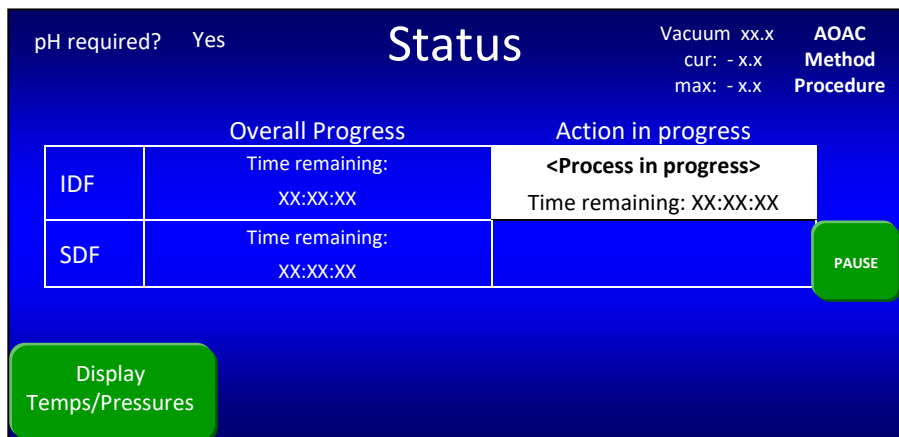

The instrument is now ready to run an SDF process that will be automatically initiated by the internal computer at the correct time.

18.2. Expert Mode – save some set-up time.

At the beginning of each new run, the instrument gives the user step-by-step instructions for set-up. These instructions are provided to make sure that all important steps are done before starting a run. After gaining experience with the instrument by running it over time, a user can choose to skip all set-up instructions except for “Check pH manually?” and “Filter minutes OK?” by enabling Expert Mode through Diagnostics.

The primary benefits of skipping most of the set-up instructions are:

- Time saved at the beginning of a run.
- The ability to change the order of set-up. For example, a user can install the IDF bags first, start the IDF process running, and then install the SDF bags.

IMPORTANT: You must be careful while in Expert Mode or you could cause problems!
The IDF/SDF and TDF analyses both start filling the SDF bag with EtOH about an hour after the IDF process starts. Therefore, if you start the IDF process, and wait more than an hour to properly install your SDF bags, the instrument will deliver EtOH to the empty bottom stations, wasting EtOH, and ruining a run.

To enter Expert Mode, follow the steps below.

18.2.1. From the Select a Function screen below, press the Diagnostics button.

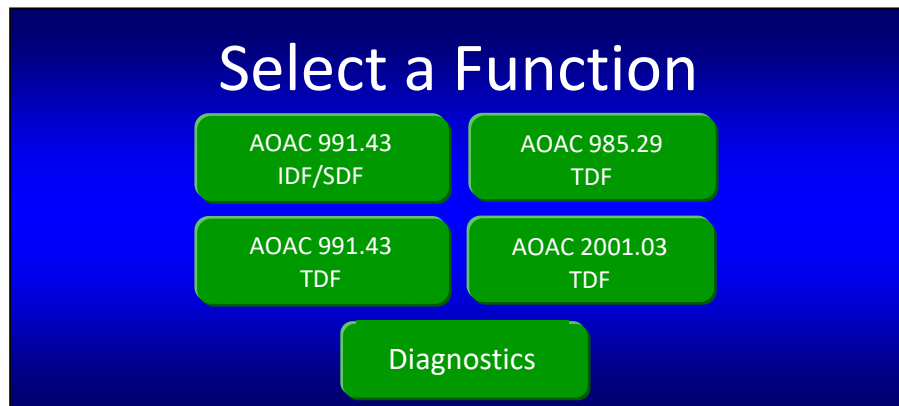

The following screen will be displayed.

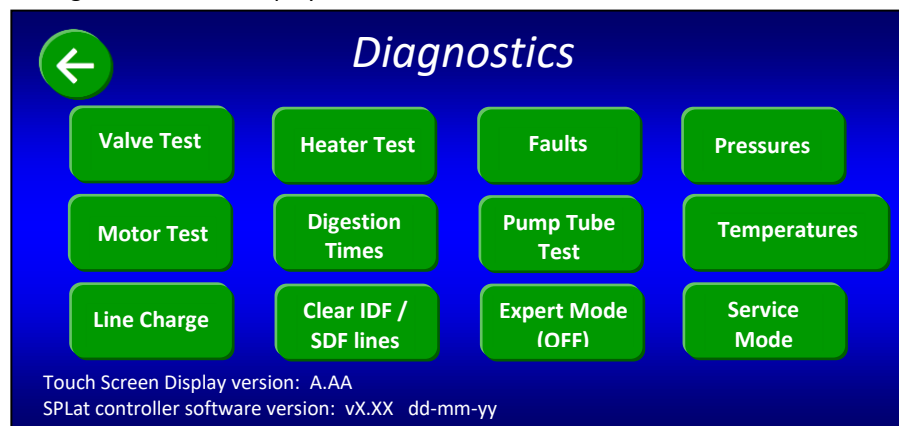

18.2.2. Press the Expert Mode button until it says “ON.”

NOTE: While in Expert Mode you will use the buttons on the Control Panel just below the Touch Screen Display to operate the clamp bars.

19. Status Screen

The screen below shows the primary sections of the instrument Status screen when running an assay. This screen is NOT displayed when running Diagnostics.

The Status screen includes sections that present information that cannot be changed by the user, along with buttons that allow the user to modify the current operations or get additional information.

For explanation purposes, we have placed a number in each section of the screen and white borders around boxes 1, 2, and 3. Your computer screen will NOT show these numbers nor will it show the borders around boxes 1, 2, and 3.

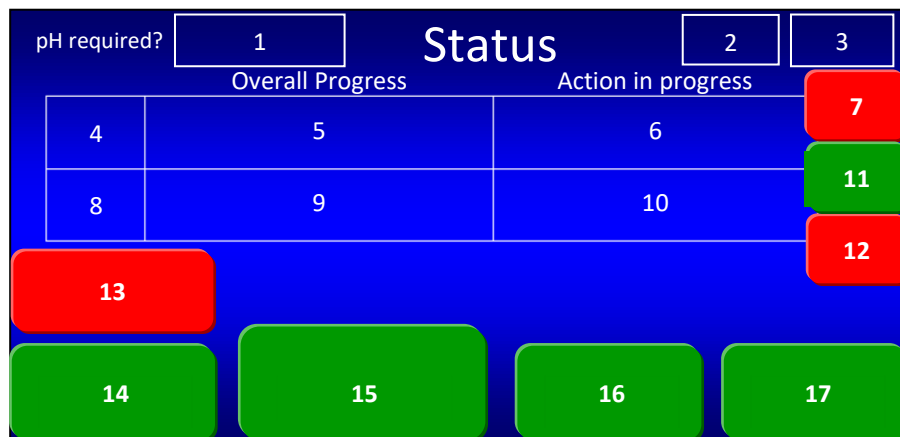

1. pH check

Box #1 contains information about the manual pH check. One of the questions you are asked before starting the automated procedure is: "Check pH manually?" If you answered "Yes" to this question, the word "YES" is displayed in box #1 until the pH has been checked, at which time the word "COMPLETE" is displayed. Otherwise, the word "NO" is displayed in this box.

2. Vacuum sensor pressure

The value shown in box #2 is the current pressure (in psi units) read by the vacuum sensor. If an error occurs during operation, and the user overrides the error to continue the operation, this box will not display a value.

3. Function and Procedure

Box #3 displays the method name along with the most recent procedure that you have started (either "IDF/SDF" or "TDF"). For example, "AOAC 991.43 IDF/SDF" is displayed when the most recent procedure started is an IDF/SDF.

NOTE: If you start a TDF procedure while you are still running the SDF process from an IDF/SDF procedure, "TDF" is displayed in this box even though an SDF process is in progress.

4. Top process – Name

Box #4 always displays "IDF" to represent an IDF process within an IDF/SDF procedure or the digestion process within a TDF procedure.

5. Top process – Progress

Box #5 displays the actual time remaining for the top process.

6. Top process – Action

Box #6 displays different detailed actions as they occur during the process that is currently running in the top section of the instrument.

7. Top process – ABORT

When pressed, button #7 aborts the process currently running in the top section of the instrument.

NOTE: This button is only displayed when an ABORT operation is allowed.

8. Bottom process – Name

Box #8 always displays “SDF” to represent an SDF process within an IDF/SDF procedure or the precipitation process within a TDF procedure.

9. Bottom process – Progress

Box #9 displays the actual time remaining for the bottom process.

10. Bottom process – Action

Box #10 displays different detailed actions as they occur during the process that is currently running in the bottom section of the instrument. When completing an SDF process while an IDF process is in progress, the “Press to continue SDF” button will appear in this box.

11. PAUSE

When pressed, button #11 pauses the timers for all processes currently in progress. This will stop the next process from starting. While paused, the button will read “CONT.” To continue the operation, press the “CONT” button.

NOTE: While paused, the instrument will continue the mechanical operation of the current step. For example, if you pause the instrument while mixing is occurring in the IDF process, the mixing paddles will continue to function even though the process timer has paused.

12. Bottom process – ABORT

When pressed, button #12 aborts the process currently running in the bottom section of the instrument.

NOTE: This button is only displayed when an ABORT operation is allowed.

13. FAULT

Button #13 is displayed if a fault occurs within the instrument. When button #13 is pressed, the Fault Screen is displayed. This screen has information about all faults that have not been cleared. See the Fault Handling section of this manual for more information.

14. Display Temps/Pressures

The instrument allows the user to view temperature and pressure readings during an assay. When button #14 is pressed, the following screen is displayed.

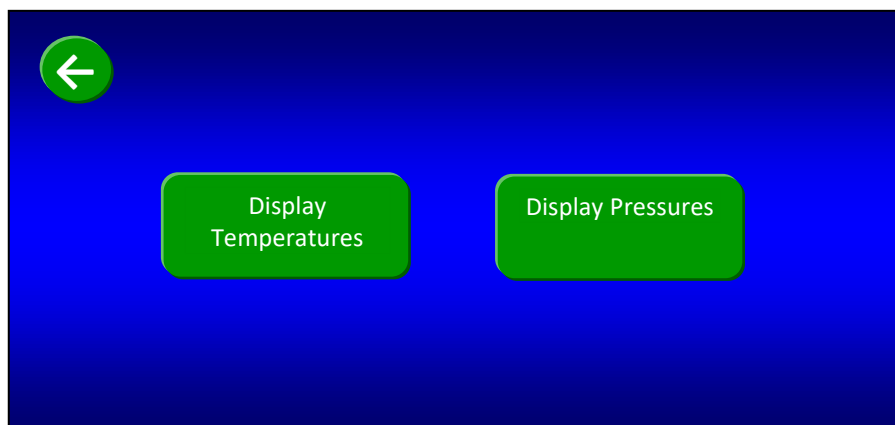

When the **Display Temperatures** button is pressed, the following screen is displayed showing the temperatures of the In-line Heater and all six Heating Paddles.

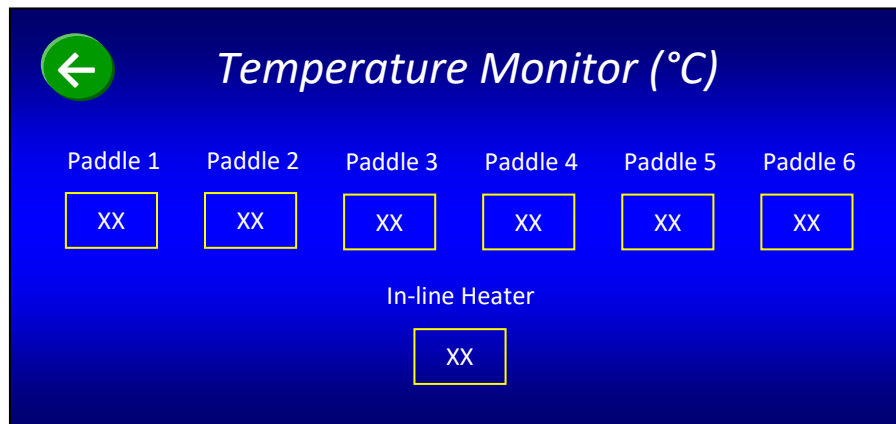

The values shown on this screen will dynamically change as the temperatures change. When the **Display Pressures** button is pressed, the following screen is displayed.

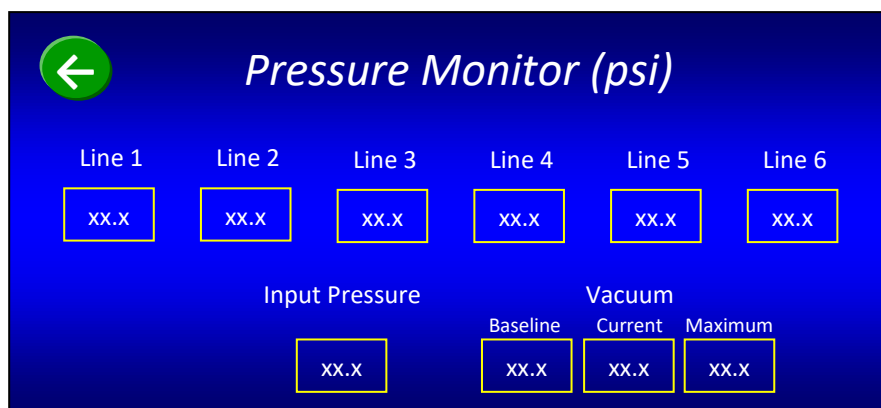

The readings shown on this screen for the input pressure and the lines to all six stations represent the absolute pressure. These values will dynamically change as the pressures change.

15. Start new procedures

Button #15 is displayed when a top process completes. At that time, the button reads: "Start New Procedure?" Button #15 is also displayed when a bottom process completes, and no top process is in progress. At that time, the button reads: "Main Menu." When button #15 is pressed, the appropriate screen for starting a new procedure is displayed.

16. Filter time increment

Button #16 is displayed when a top or bottom process begins its filter action. At that time, the button reads: "Filter Time +." When button #16 is pressed, the remaining filter time is increased by one minute for every time the button is pressed up to a limit of 54 additional minutes.

17. Filter bypass or Precipitation bypass

Button #17 is displayed when a top or bottom process begins its filter action or when a bottom process begins its precipitation phase. During the filter actions, the button reads: "Filter bypass." During a precipitation phase, the button reads: "Precipitation bypass." When pressed, button #17 instructs the instrument to stop the filter or precipitation action and start the next action.

NOTE: If you mistakenly increase your filter time using the Filter time increment button, you can use the Filter bypass to stop the filter process before the additional filter time occurs.

This page intentionally left blank

20. Fault Handling

When the instrument detects a problem, it generates a fault. Some faults require the instrument to abort operations. Other faults will allow the instrument to continue operation.

NOTE: The computer clears all fault codes at the beginning of each new procedure. However, if you start a new procedure without correcting the cause of a fault, it will continue to re-appear.

The screen below shows the primary sections of the instrument fault screen.

The Faults screen includes sections that present information that cannot be changed by the user, along with buttons that allow the user to modify the current operations or get additional information. The back button is available for returning to the Status screen or the Diagnostics screen depending on the function you were doing when you entered the Faults screen.

For explanation purposes, we have placed a number in each section of the screen. Your computer screen will NOT show these numbers.

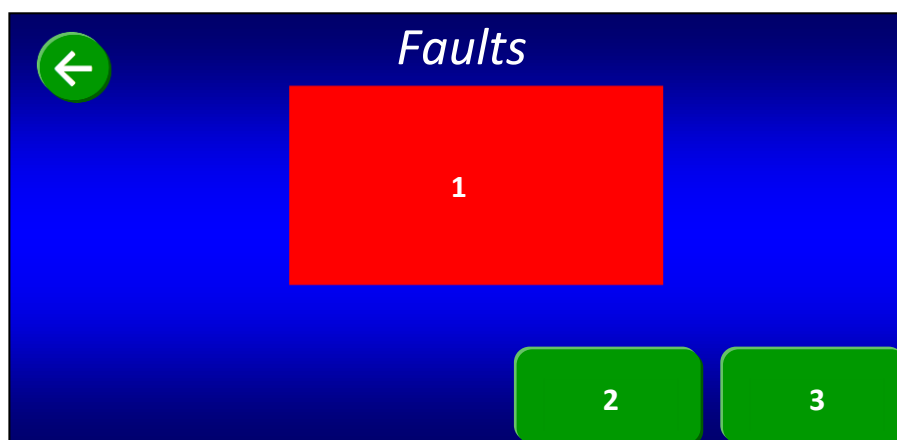

1. Fault description

Box #1 contains the description of a fault that has recently occurred.

2. Reset fault after it has been repaired

Button #2 is only displayed when a low input pressure fault occurs. When button #2 is pressed, the fault is reset.

3. Next fault

Multiple faults can occur during a procedure. Pressing button #3 will walk through all of the existing faults.

List of Faults and Alerts (see www.ankom.com for the most current Fault Handling information)

#	Name	Description	Result	Correction
E1	Paddle Temperature Sensor Failure	One of the Paddle Sensors is reporting erroneous information.	Process continues to run.	See "Technical FAQs" section at www.ankom.com .
E2	In-line Heater Temperature Sensor Failure	The device that heats the fluid before delivery is reporting a temperature that is lower than the specified range.	In-progress processes are aborted.	See "Technical FAQs" section at www.ankom.com .
E3	Paddle Heater Over Temp	One of the Paddle Sensors is reporting a temperature that is higher than the specified range.	IDF process is aborted. SDF process continues.	See "Technical FAQs" section at www.ankom.com .

#	Name	Description	Result	Correction
E4	In-line Heater Over Temp	The device that heats the fluid before delivery is reporting a temperature that is higher than the specified range.	In-progress processes are aborted.	See "Technical FAQs" section at www.ankom.com .
E5	Paddle Heater Under Temp	One of the Paddle Sensors is reporting a temperature lower than the specified range.	IDF process continues. SDF process unaffected.	See "Technical FAQs" section at www.ankom.com .
E7	In-line Heater Under Temp (IDF Water Rinse)	The device that heats the fluid before delivery is reporting a temperature that is lower than the specified range for the IDF Water Rinse phase.	IDF process continues. SDF process unaffected. Failed heater is disabled.	See "Technical FAQs" section at www.ankom.com .
E8	In-line Heater Under Temp (SDF EtOH95 delivery)	The device that heats the fluid before delivery is reporting a temperature that is lower than the specified range for the SDF EtOH95 Delivery phase.	IDF process unaffected. SDF process continues. Failed heater is disabled.	See "Technical FAQs" section at www.ankom.com .
E9	In-line Heater Cooling Failure	The device that heats the fluid before delivery is reporting a temperature that is higher than the specified range for the Water-Cooling phase.	In-progress processes are aborted.	See "Technical FAQs" section at www.ankom.com .
E10	High Line Pressure	The pressure in one or more of the delivery tubes is higher than the specified values.	In-progress processes are aborted.	See "Technical FAQs" section at www.ankom.com .
E11	Low N ₂ Input Pressure	The pressure at the input port is lower than the specified range.	In-progress processes are frozen in time. The mixer is stopped. The N ₂ filter is disabled until fault is corrected.	See "Technical FAQs" section at www.ankom.com .
E12	High N ₂ Input Pressure	The pressure at the input port is higher than the specified range.	Fault is reported. All in-progress processes continue.	See "Technical FAQs" section at www.ankom.com .
E13	Tubing Failure	At least one of the pump tubes has broken OR one of the output valves is not closing.	In-progress processes are aborted.	See "Technical FAQs" section at www.ankom.com .
E14	Empty Chemical Container	The instrument detected a weak supply line vacuum. One or more chemical containers may be empty, or there may be a cracked fitting or tube.	A message is displayed. User can choose to retry, override, or abort. Override will prevent the error message for the rest of the run.	See "Technical FAQs" section at www.ankom.com .
E15	Supply Line Plugged	The instrument detected a high supply line vacuum. One or more chemical supply lines are plugged or the associated valves are stuck in the closed position.	A message is displayed. User can choose to retry, override, or abort. Override will prevent the error message for the rest of the run.	See "Technical FAQs" section at www.ankom.com .

21. Diagnostics Mode

To help solve problems that may occur while running the ANKOM^{TDF} Dietary Fiber Analyzer, and to assist with periodic maintenance procedures, a computer-controlled Diagnostics Mode is available through the Touch Screen Display.

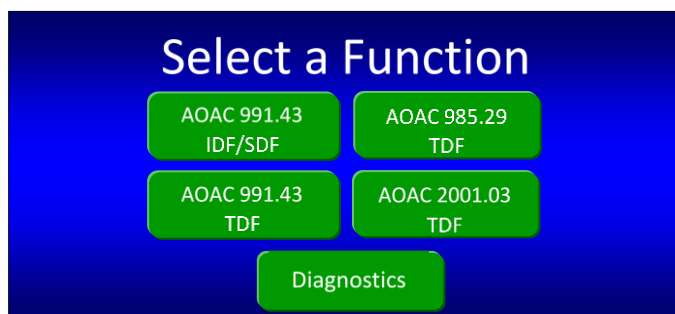

To access the Diagnostics Mode, press the **Diagnostics** button on the screen above. The following screen will be displayed.

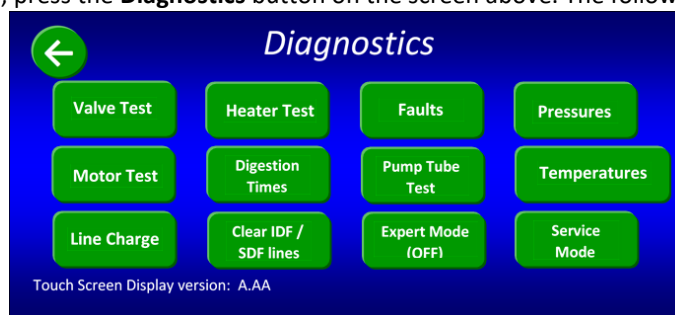

This screen has buttons for each of the available diagnostic procedures. Descriptions of each procedure are provided below.

Valve Test

When you press the **Valve Test** button on the Diagnostics screen, the following screen will be displayed.

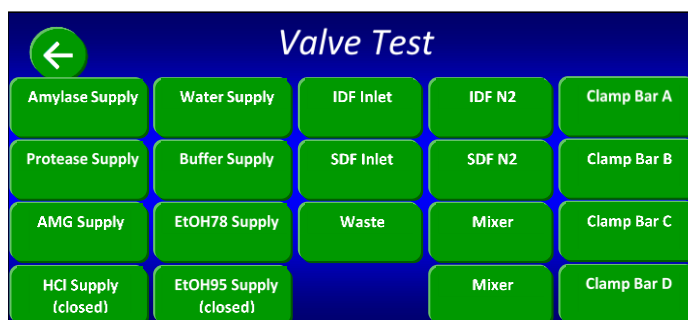

When this screen is displayed, the Control Panel buttons located below the Touch Screen Display are disabled. Pressing the buttons on this screen will actuate specific valves (with the exception of the **Mixer Duty Cycle** button).

NOTE:

The value on the Mixer Duty Cycle screen is only used during Diagnostics and in an AOAC 2009.01/2011.25 assay during the 16 hour Amylase/AMG digestion and Trizma phases.

Heater Test

When you press the **Heater Test** button on the Diagnostics screen, the following screen will be displayed.

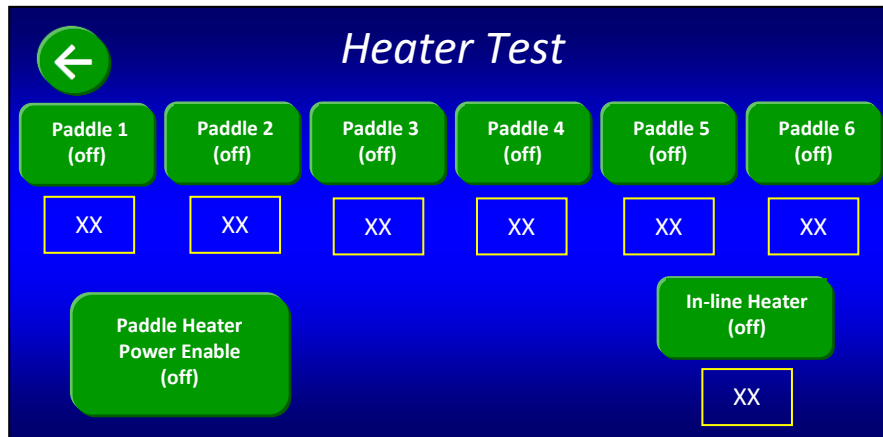

With the **Paddle Heater Power Enable** button set to “on”, pressing any of the **Paddle 1** through **Paddle 6** buttons will turn the heat on for the specific paddle. Pressing the **In-line Heater** button will turn the In-line Heater on and light the LED located below the Touch Screen Display on the Control Panel. The heater temperatures are shown below each heater button. Once the In-line Heater climbs to 50 degrees, turn off the In-line heater. The temperature will continue to rise to about 60 degrees until it starts to cool. This confirms that the In-line heater is functioning properly.

IMPORTANT: Do not let the In-line heater heat past 50 degrees. If the temperature climbs above 100 degrees, there is a possibility of damage to the instrument. After completing the Heater Test, immediately turn all heaters off.

Faults

When you press the **Faults** button on the Diagnostics screen, the Faults screen is displayed. See the “Fault Handling” section of this manual for more information.

Pressures

When you press the **Pressures** button on the Diagnostics screen, the following screen will be displayed.

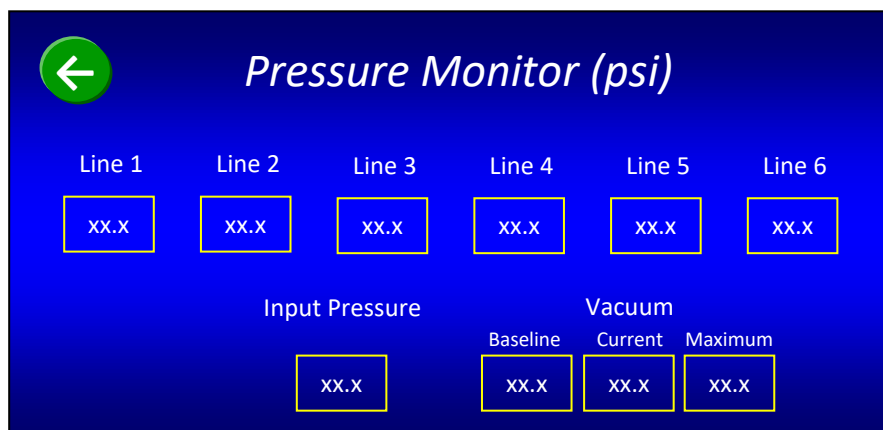

The readings shown on this screen for the input pressure and the lines to all six stations represent the absolute pressure. These values will dynamically change as the pressure changes.

Motor Test

When you press the **Motor Test** button on the Diagnostics screen, the following screen will be displayed.

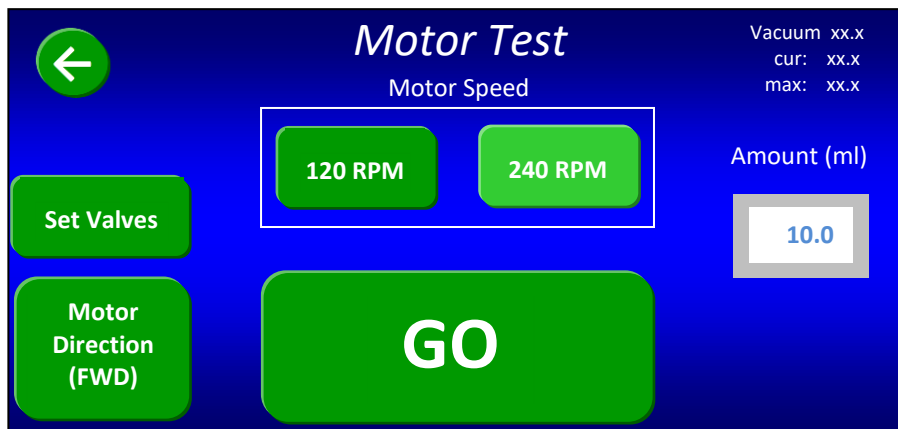

NOTE: To achieve the appropriate volume in the filter bags, the concentrations of the HCl and NaOH solutions were modified to accomplish the pH adjustment in a manner equivalent to the AOAC 985.29 and 2001.03 methods.

This diagnostic allows you to test the motor at different speeds (default is 240 RPM) and directions using different amounts of fluid. Default valve settings are Water Supply open and Waste Output open. If you want to change valve settings, before pressing the **GO** button to start the Motor Test, press the **Set Valves** button. The following screen will be displayed.

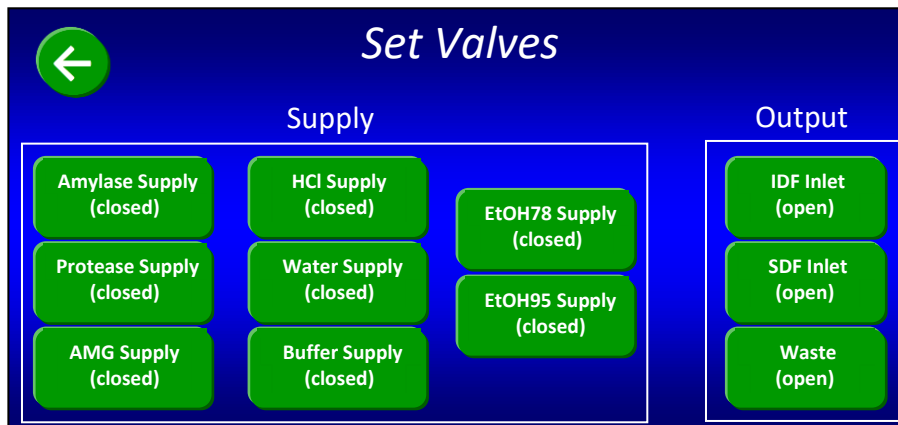

This diagnostic also displays the maximum pressure read from the vacuum sensor during the test. The value starts at zero and will display a value while the motor is running and when it stops. This can be used for troubleshooting.

IMPORTANT: Running the Motor Test could leave fluid in some of the lines. After running a Motor Test, always run the Clear IDF/SDF Lines diagnostic.

Digestion Times

When you press the **Digestion Times** button the following screen will be displayed.

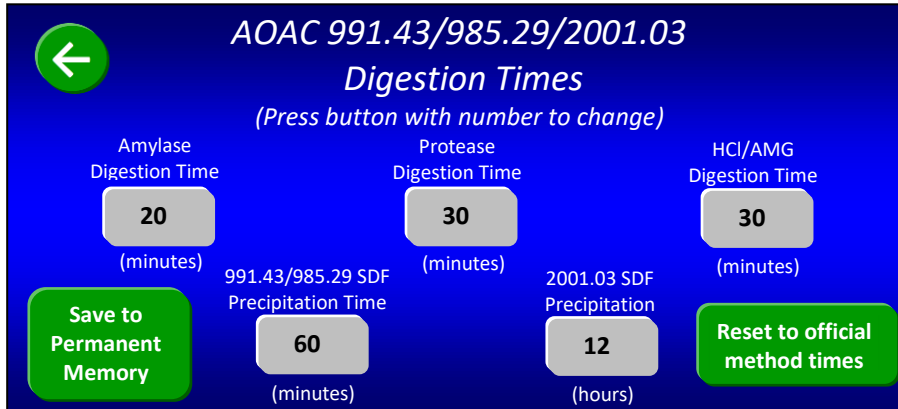

This diagnostic allows you to modify the times used by the computer for the digestion processes. This can be helpful when troubleshooting or demonstrating the instrument. If you press the **Save to Permanent Memory** button, the values you entered will be saved until you change them again by using this diagnostic. If you do not press the **Save to Permanent Memory** button, the values you entered will be saved until power is turned off, or until you change them again by using this diagnostic.

IMPORTANT: If you start a new procedure with Digestion Times other than the official method times, a message will be displayed on the Touch Screen Display that allows you to reset the values. A Reset from this Warning Screen is only temporary. Use the Digestion Times screen in Diagnostics to make the reset permanent.

Pump Tube Test

When you press the **Pump Tube Test** button on the Diagnostics screen, the following screen will be displayed.

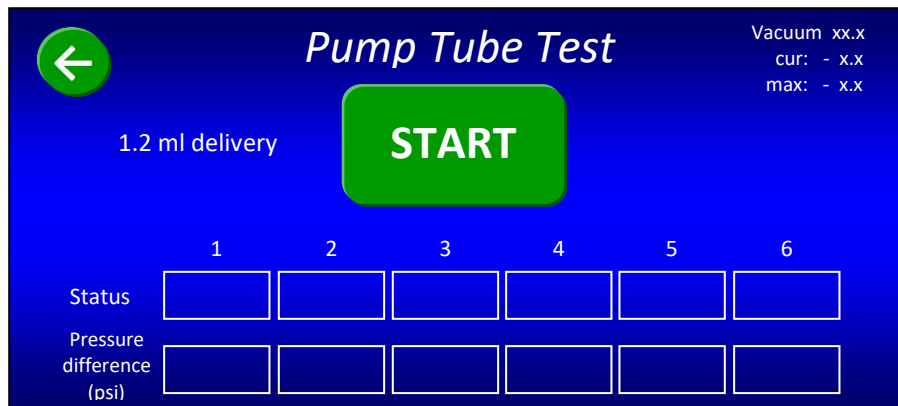

This diagnostic test tests the integrity of the tubing from the pump to the inlet valves (IDF, SDF, and Waste). When you press the **START** button, the following screen will be displayed.

When you press one of the **Continue** buttons, the Pump Tube Test screen is once again displayed with the bottom part of the screen showing the status of each tube. This diagnostic is automatically executed at the beginning of each new IDF/SDF or TDF run.

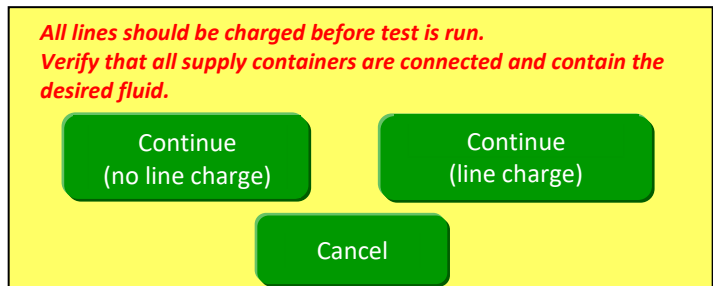

Temperatures

When you press the **Temperatures** button on the Diagnostics screen, the following screen will be displayed.

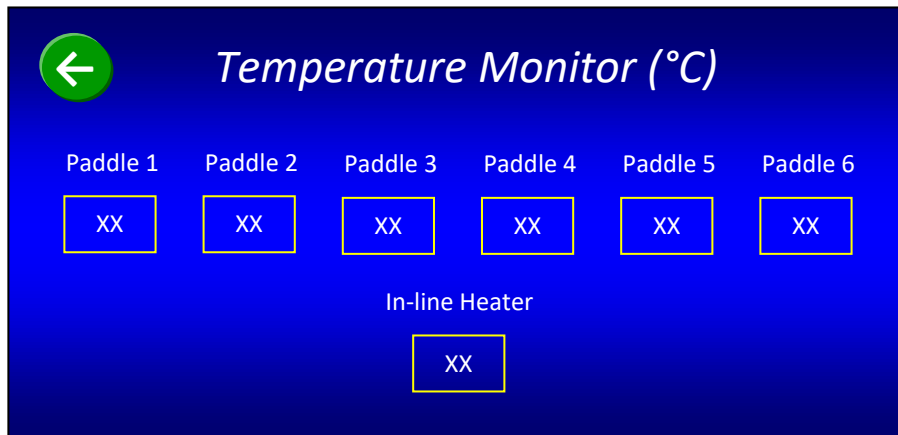

The readings for the In-line Heater and all six Heating Paddles dynamically change as the temperature changes.

Line Charge

When you press the **Line Charge** button on the Diagnostics screen, the following screen will be displayed.

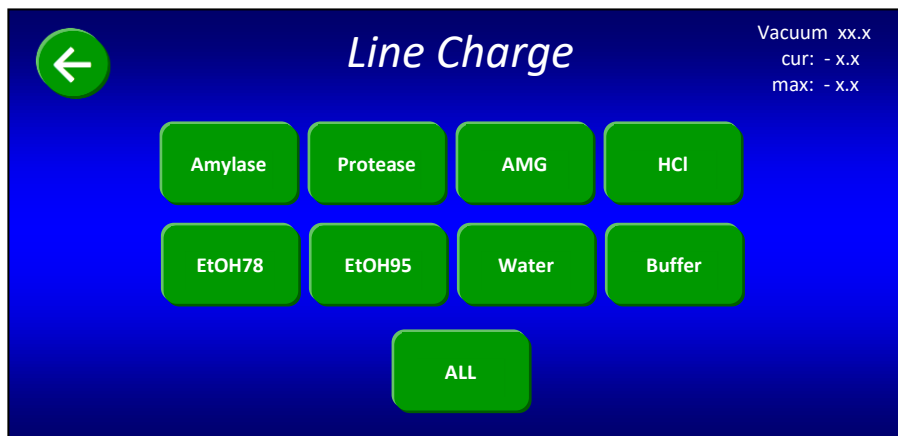

This diagnostic allows you to pump individual fluids, or all of the fluids, into the lines from the Chemical Containers to the Tubing Support Panel. If by accident you run out of any fluid during a normal IDF/SDF or TDF run, there may not be enough fluid in the lines for the next assay. In that case you should use this diagnostic to re-fill the lines that ran out.

A button will change color as the associated line is being charged. A line is charged when its associated button returns to its original green color.

Clear IDF/SDF Lines

When you press the **Clear IDF/SDF Lines** button on the Diagnostics screen, the IDF and SDF lines are cleared of any fluids. Before running this diagnostic, place small waste cups at each IDF and SDF station under the nozzles and close the Front Cover of the instrument.

Expert Mode

When Expert Mode is "ON," all of the question screens in the IDF/SDF and TDF procedures are bypassed except for the "Check pH manually?" and "Filter minutes OK?" screens. See the "Productivity Enhancement" section of this manual for more information about Expert Mode.

IMPORTANT: **You must be careful while in Expert Mode or you could cause problems!**
The IDF/SDF and TDF analyses both start filling the SDF bag with EtOH about an hour after the IDF procedure starts. Therefore, if you start an IDF procedure, and wait more than an hour to properly install your SDF bags, the instrument will deliver EtOH to the empty bottom stations, wasting EtOH, and ruining a run.

Service Mode

When you press the **Service Mode** button on the Diagnostics screen, the following screen will be displayed.

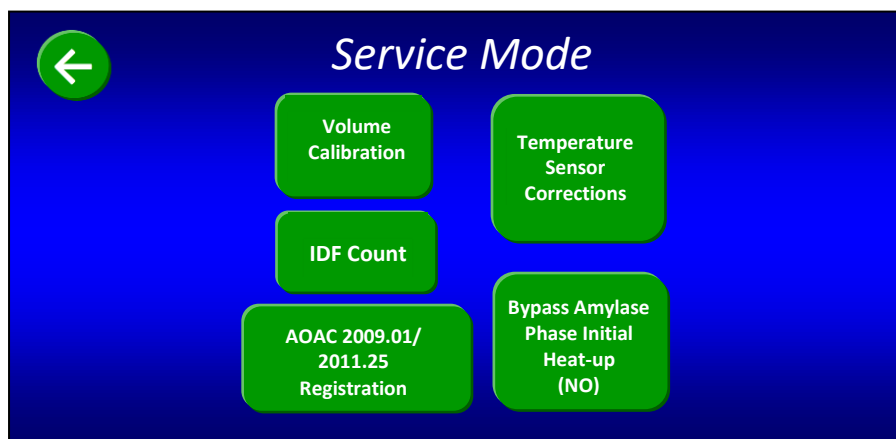

Service Mode – Volume Calibration

Refer to the "QC / Calibration Checks" section of this manual for details about this diagnostic.

Service Mode – Temperature Sensor Corrections

Refer to the "QC / Calibration Checks" section of this manual for details about this diagnostic.

Service Mode – Bypass Amylase Phase Initial Heat-up

For digestions to occur at the correct temperature for the correct amount of time, the instrument's computer waits for the heating paddles to heat up to the target temperature before starting the digestion timer. When this button displays the word "YES," the instrument's computer will start the digestion timer without waiting for the heating paddles to reach the target temperature.

IMPORTANT: Only use this option when demonstrating or troubleshooting the instrument. If the bypass is enabled, a warning screen will be displayed at the start of a new run. At that time you can tell the computer to disable the bypass and return to the standard operating mode of waiting for the heating paddles to reach the target temperature before starting the digestion timer.

Service Mode – IDF Count

When you press the **IDF Count** button on the Service Mode screen, the following screen will be displayed.



From this screen, you can see the number of digestion operations that have been done on this instrument.

Service Mode – AOAC 2017.16/2022.01 Registration

When you purchase the upgrade to Total Integrated Dietary Fiber, ANKOM Technology will provide you with a registration number that you will use to configure your instrument to run the AOAC 2017.16 and 2022.01 methods. When you press the **AOAC 2017.16.01/2022.01 Registration** button on the Service Mode screen, the following screen will be displayed.

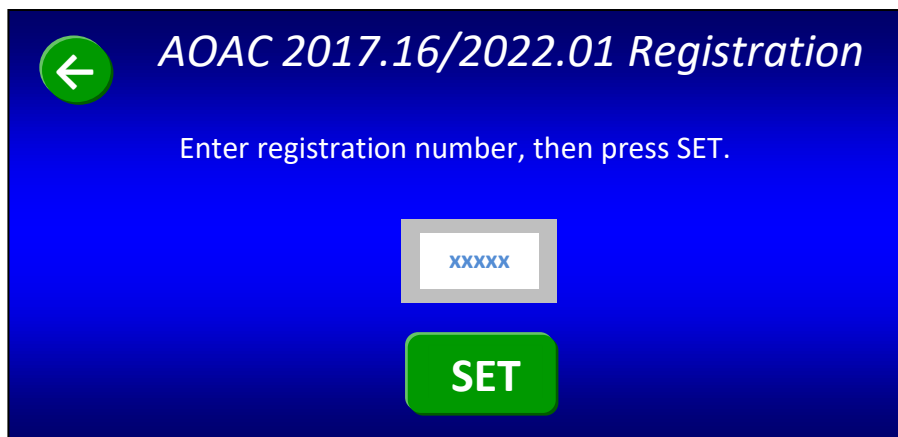

To enable the AOAC 2017.16/2022.01 methods, enter the 5-digit registration number provided by ANKOM Technology in the white box with the gray border and press the **SET** button. If you enter an incorrect number, the instrument will tell you to try again.

This page intentionally left blank

22. Periodic Maintenance

Flush and purge the fluid lines

On a monthly basis (or, for more optimal performance, once a week), follow the Line Flushing Procedure in Appendix C.

IMPORTANT: This same procedure should also be done BEFORE an instrument will be out of use for one week or longer.

Inspect and clean the spray tips at each IDF and SDF station

On a monthly basis (or more frequently depending on usage), follow the steps below to inspect and clean the delivery nozzles.

1. Observe the spray capability during the rinse cycle of an assay.
2. Remove any plugged nozzles by pulling and turning them (they are friction fit to the delivery tubes).
3. Clean out the six holes using the Spray Tip Cleaning Tool Kit (part # TDF94) to regain unobstructed fluid passage.
4. Clean out any foreign matter left by the process (pressurized air may be used to blow out the holes).
5. Reinstall the spray tips by turning and pushing them onto the delivery tubes.

Inspect and clean chemical containers and filters

On a monthly basis (or more frequently depending on usage), follow the steps below to inspect and clean the chemical containers and filters.

1. Inspect the containers, container filters (at the end of the tubing inside each container), and internal tubing, checking for any precipitate, particles, or foreign matter that may be plugging the filters, the tubes, or settled at the bottom of the container.
2. Clean the filters by running them under fast running water. Replace as needed.
3. Rinse the containers out with water and let air dry as needed.

Regularly clean the instrument surfaces

Wipe down the surface of the instrument whenever spills occur, or splatters are observed.

Inspect tubing for wear or leaks

On a monthly basis (or more frequently depending on usage), follow the steps below to inspect the pneumatic and silicone tubing.

1. With the instrument connected to pressurized nitrogen, inspect the pressurized air lines. Listen for any audible leaks and check for cracks or kinks.
2. Run a Pump Tube Test as described in the Diagnostics Mode section of this manual. Confirm that pressure results are passing. Inspect the silicone tubing for leaks during this test.
3. Replace tubing as needed.

Maintain pinch valve tubing

On a yearly basis, replace all pinch valve tubing (TDF71) at the IDF, SDF, waste, and enzyme pinch valves. Refer to TDF Service Procedure- Tube Replacement Pinch valves (TS005), located on the ANKOM website.

Lubricate peristaltic pump and pump tubing (ONLY if TDF99 Long-Life Tube Sets are installed)

On a monthly basis, apply TDF99 Synthetic Grease to the peristaltic pump tubing and rollers to reduce wear and extend life of the pump tubing. This should be done before the monthly volume calibration check. Refer to TDF Service Procedure- Long-Life Pump Tube Replacement TDF99 (TS028), located on the ANKOM website for full details.

Volume Calibration

A Volume Calibration should be performed upon initial setup and once a week for the first month of use. After the first month, perform a volume calibration once a month thereafter and immediately after installing new pump tubes. It is important that the instrument is calibrated to verify that it is delivering the correct amount of fluid through the pump. Refer to the Volume Calibration Procedure section in the manual.

23. Troubleshooting & Replacement Parts

The ANKOM Technology web site has the most current troubleshooting and replacement parts information. Therefore, if you have any questions about the operation of your ANKOM^{TDF} Dietary Fiber Analyzer, or if you need replacement parts, please visit our web site at **www.ankom.com**.

24. Volume Calibration Procedure

You will use the Volume Calibration diagnostic to check and calibrate the Fluid Delivery system. This diagnostic allows you to verify that the instrument is delivering the correct amount of fluid through the pump. This calibration should be done upon initial set-up, once a week for the first month of use, once a month thereafter and after installing new pump tubing.

24.1. Perform a Volume Calibration

- 24.1.1. To run the Volume Calibration procedure, you will need the two sets of volume calibration cups that were included with the instrument. Follow the steps below.
- 24.1.2. Label the first set of six cups numbers 1-6. Pre-weigh and record their weights on the Volume Calibration Record Worksheet located on the USB thumb drive that was sent with the instrument. These cups will serve as your "Calibration Cups." The second set of six cups do not need to be numbered or weighed and will serve as your "Spare Cups."
- 24.1.3. Press the **Diagnostics** button. The following diagnostics screen will be displayed.

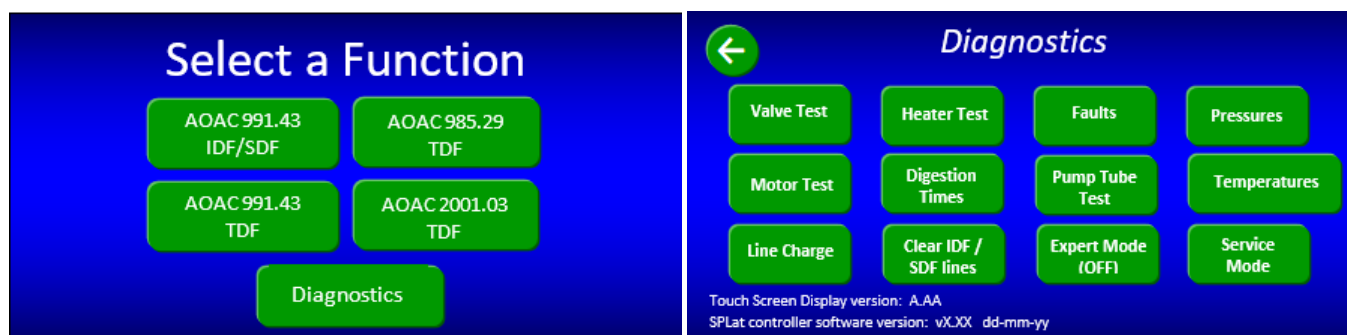

- 24.1.4. Press the **Service Mode** button. The following screen will be displayed.

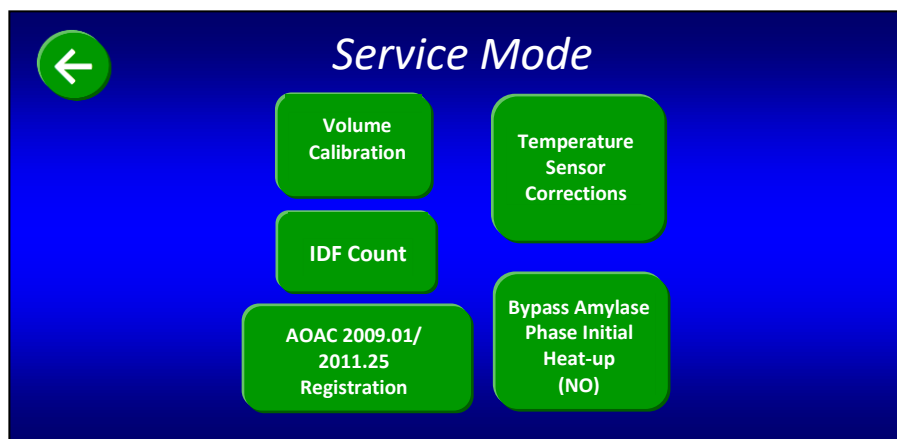

24.1.5. Press the **Volume Calibration** button. The following screen will be displayed.

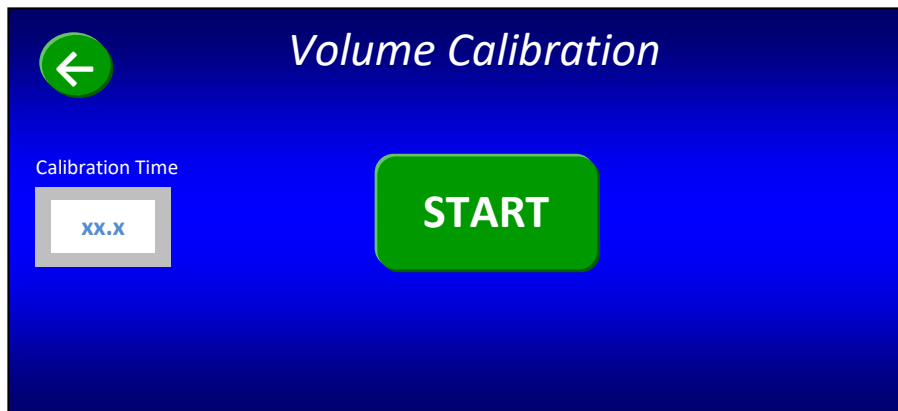

24.1.6. Press the **START** button on the Volume Calibration screen above. The following screen will be displayed.

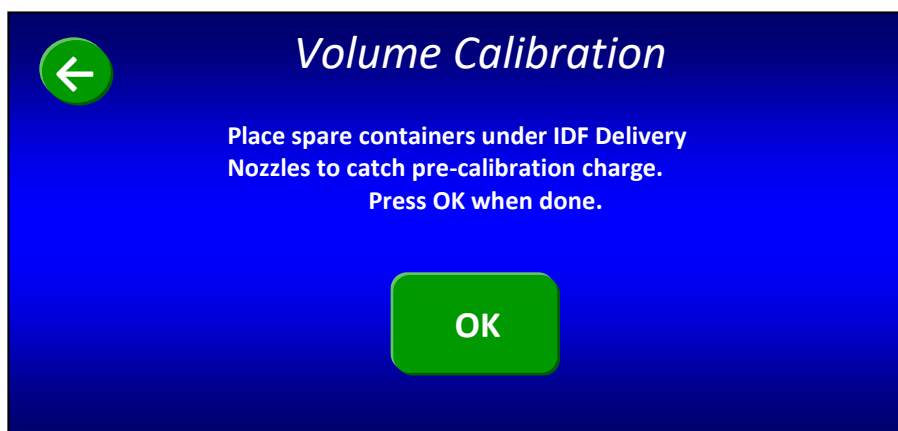

24.1.7. Install the six spare cups under the IDF Delivery Nozzles.



- 24.1.8. With the cups in place, press the **OK** button. After fluid empties into the cups, the following screen will be displayed.

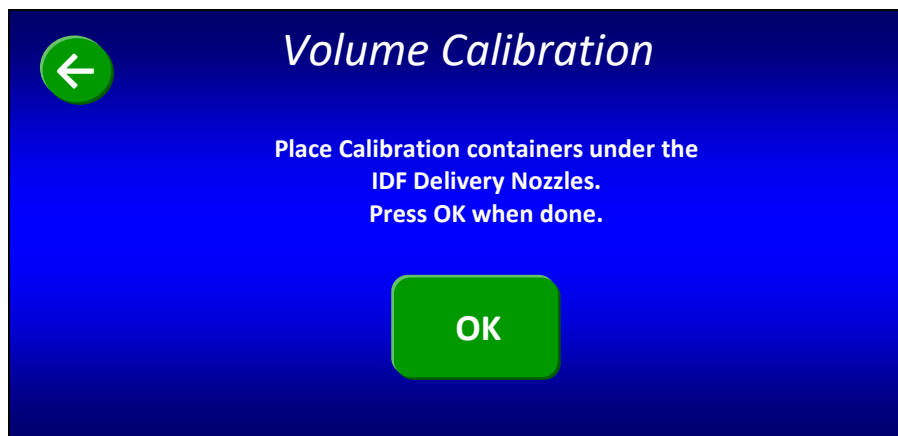

- 24.1.9. Remove the spare cups and install the six calibration cups under the IDF Delivery Nozzles and press the OK button.



While the fluids are being delivered, the following screen will be displayed.

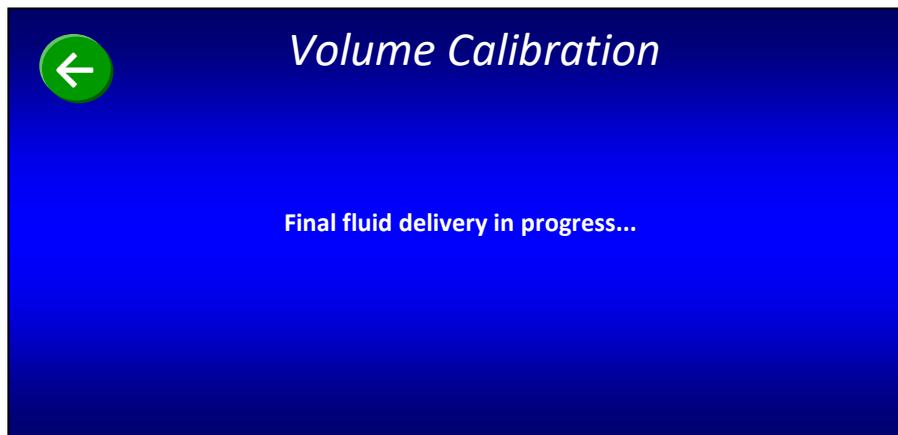

When the fluid delivery is complete, the following screen will be displayed.

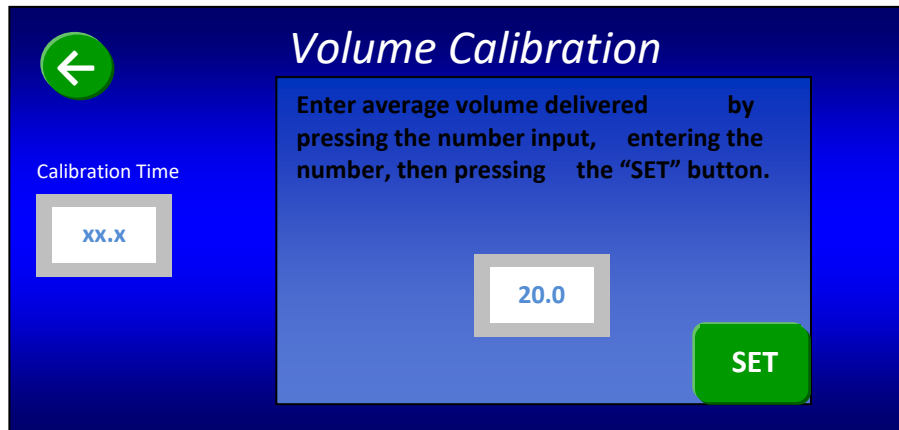

- 24.1.10. Carefully remove the Calibration Cups, weigh each one and record them on the Volume Calibration Record Worksheet. The AVERAGE delivery should fall in the range of 19.75-20.25g.
- 24.1.11. If you are not using the Calibration Record Worksheet provided by ANKOM, you will manually determine the amount of fluid delivered by doing the following: subtract the weight of the empty calibration cups from the weight of the calibration cups that now contain fluid. Given that 1g of water equals 1 ml of water, convert the weight in grams to volume in ml.
- 24.1.12. Expected range is **19.75-20.25g**
 - a. If the AVERAGE falls **within** the expected range, leave the default value of "20.0" and simply press the green SET button (DO NOT enter a value of "00.0").
 - b. If the AVERAGE falls **outside** of the expected range, press the number input box on the above screen (it shows "20.0" as the default) and enter the average ml of fluid delivered; then press the **Enter** button to capture the value and exit the input screen.

IMPORTANT: DO NOT enter a value of "00.0".

- 24.1.13. Press the **SET** button. This modifies the Calibration Time and stores the new value in memory.

25. Temperature Sensing

The instrument uses temperature sensors on the heating paddles to monitor and control the temperature of the digestion phases. Because the sensors have a tolerance range, you can set offsets to correct for differences in temperature sensors.

25.1. To calibrate the Temperature Sensing system, follow the steps below.

- 25.1.1. Start an IDF/SDF analysis on the instrument without using any samples. See the "IDF/SDF Analysis" section of this manual for more details.
- 25.1.2. After 15 minutes of time has elapsed in the Protease phase of the IDF process, press the **Display Temperatures** button on the Status Screen.
- 25.1.3. With the front cover of the instrument in the down position (as it would be during normal operation), place a standard Thermometer in each of the six IDF bags and record on a sheet of paper the temperature readings from the Thermometer and from the sensors. The temperature should be 60°C at this time.
- 25.1.4. Abort the IDF/SDF run. The following screen will be displayed.

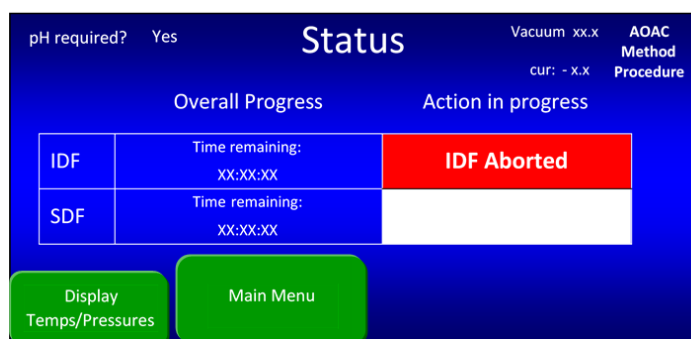

- 25.1.5. Press the **Main Menu** button. The following screen will be displayed.

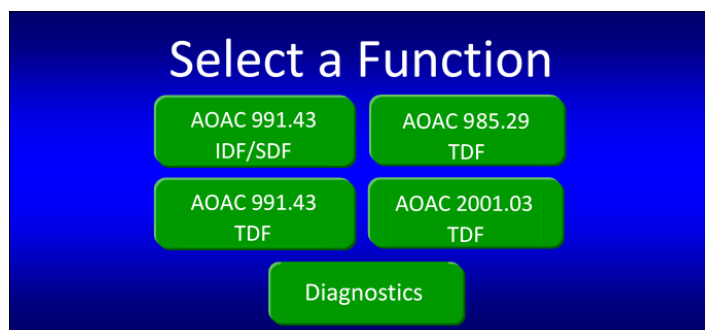

- 25.1.6. Press the **Diagnostics** button. The following screen will be displayed.

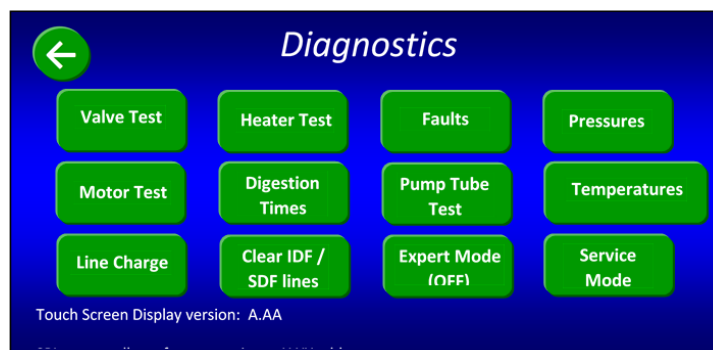

25.1.7. Press the **Service Mode** button. The following screen will be displayed.

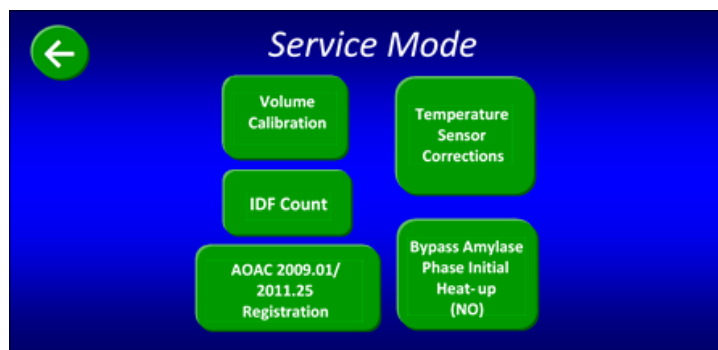

25.1.8. Press the **Temperature Sensor Corrections** button. The following screen will be displayed.

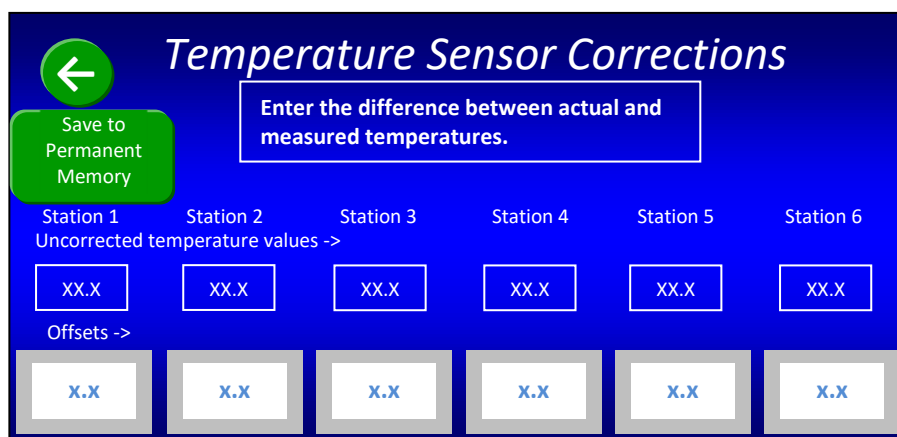

- 25.1.9. Press the white button with the gray border for each sensor that did not show the same value as the thermometer and type in the difference between what the sensor reported, and the actual temperature shown on the thermometer.
- 25.1.10. Press the **Save to Permanent Memory** button after setting the offsets. They will remain until they are changed using this diagnostic.
- 25.1.11. Repeat steps of this procedure to check that the sensors read within $\pm 2^\circ$ of the Thermometer.

26. Appendix A – Reagents (AOAC 991.43, 985.29, 2001.03)

Use Deionized (DI) or Distilled (DW) water throughout.

Best practices for solution preparation

The best practice for preparation of solutions is to make it fresh and to use it within two days of refrigerated storage. This is true especially for the sodium maleate buffer solution which can readily support microbial growth. Contamination and lack of cleanliness can dramatically affect shelf life of solutions.

Enzyme solutions

ANKOM has chosen to use the activity numbers specified by Megazyme based on their extensive research and in accordance with each official method. As always, refer to the specific method for Enzyme purity information, and run specified test samples as appropriate.

- (a) *Enzyme solutions*—To make your enzyme solutions for use in the ANKOM^{TDF} Dietary Fiber Analyzer, dilute ANKOM Concentrate enzymes (TDF80/TDF81, TDF82/TDF83, TDF84/TDF85) with DI or DW water according to the Enzyme Dilution Table below.

AOAC 991.43	Enzyme	Enzyme Concentration	
	α-Amylase	150 ± 15 Ceralpha U/g sample	
	Amyloglucosidase	600-990 Glucose U/g sample	
	Protease	30-40 Tyrosine U/g sample	
ANKOM ^{TDF}	Enzyme	*Enzyme Concentration	Dilute with DI or DW water
	α-Amylase	150 Ceralpha U/ml	TDF80 or TDF81: 5 ml to 25 ml
	Amyloglucosidase	652 Glucose U/ml	TDF84 or TDF85: 5 ml to 25 ml
	Protease	35 Tyrosine U/ml	TDF82 or TDF83: 5ml to 25 ml
*The ANKOM ^{TDF} Dietary Fiber Analyzer delivers 1 ml of each enzyme solution to each of the six stations per run. If you are not using the ANKOM enzyme concentrates, you must prepare enzyme solutions to the recommended concentration, and it must include 0.02% w/v of Sodium Azide (to prevent microbial growth).			

AOAC 985.29	Enzyme	Enzyme Concentration	
	α-Amylase	300 ± 30 Ceralpha U/g sample	
	Amyloglucosidase	600-990 Glucose U/g sample	
	Protease	30-40 Tyrosine U/g sample	
ANKOM ^{TDF}	Enzyme	*Enzyme Concentration	Dilute with DI or DW water
	α-Amylase	300 Ceralpha U/ml	TDF80 or TDF81: 10 ml to 25 ml
	Amyloglucosidase	652 Glucose U/ml	TDF84 or TDF85: 5 ml to 25 ml
	Protease	35 Tyrosine U/ml	TDF82 or TDF83: 5 ml to 25 ml
*The ANKOM ^{TDF} Dietary Fiber Analyzer delivers 1 ml of each enzyme solution to each of the six stations per run. If you are not using the ANKOM enzyme concentrates, you must prepare enzyme solutions to the recommended concentration, and it must include 0.02% w/v of Sodium Azide (to prevent microbial growth).			

AOAC 2001.03	Enzyme	Enzyme Concentration
	α-Amylase	300 ± 30 Ceralpha U/g sample
	Amyloglucosidase	600-990 Glucose U/g sample
	Protease	35-75 Tyrosine U/g sample

ANKOM ^{TDF}	Enzyme	*Enzyme Concentration
	α-Amylase	300 Ceralpha U/ml
	Amyloglucosidase	652 Glucose U/ml
	Protease	35 Tyrosine U/ml

*The ANKOM^{TDF} Dietary Fiber Analyzer delivers 1 ml of each enzyme solution to each of the six stations per run. ANKOM does not sell enzyme concentrates to be used in this method. However, make sure enzyme solutions are prepared per official method and containing 0.02% w/v of Sodium Azide (to prevent microbial growth).

General solutions common to AOAC 991.43, 985.29, and 2001.03 methods

- (b) *Ethanol 95%*.
- (c) *Ethanol 78%*—Place 821 ml of 95% ethanol into a 1 L volumetric flask. Dilute to volume with H₂O.
- (d) *Diatomaceous earth (DE)*—(ANKOM DE1, DE2, or equivalent).
- (e) *Acetone*—reagent grade.

General solutions unique to the AOAC 991.43 method

- (f) *MES*—2-(*N*-Morpholino) ethanesulfonic acid (No. M-8250, Sigma Chemical Co., or equivalent).
- (g) *TRIS*—Tris(hydroxymethyl)aminomethane (No. T-1503, Sigma Chemical Co., or equivalent).
- (h) *MES-TRIS buffer solution*— 0.05M MES, 0.05M TRIS, pH 8.2 at 24°C. Dissolve 19.52 g MES and 12.2 g TRIS in 1.7 L H₂O. Adjust pH to 8.2 with 6*N* NaOH and dilute to 2 L with H₂O. (*Note:* It is important to adjust pH to 8.2 at 24°C. However, if buffer temperature is 20°C, adjust pH to 8.3; if temperature is 28°C, adjust pH to 8.1. For deviations between 20 and 28°C, adjust by interpolation.)
- (i) *Hydrochloric acid solution (AOAC 991.43)*—0.561*N*. Dilute 93.5 ml of 6*N* HCl to 1 L with H₂O.

General solutions unique to the AOAC 985.29 and 2001.03 methods

- (j) *Hydrochloric acid solution (AOAC 985.29)*—0.65*N*. Dilute 325 ml of 1*N* HCl to 500 ml with H₂O.
- (k) *Phosphate buffer solution*— 0.08M, pH 6.0. Dissolve 1.40 g Sodium Phosphate dibasic, anhydrous (Na₂HPO₄) (or 1.75 g dihydrate) and 9.68 g Sodium Phosphate monobasic monohydrate (NaH₂PO₄) (or 10.94 g dihydrate) in a 1 L volumetric flask. Dilute to 1 L with H₂O. Adjust pH to 6.0.
- (l) *Sodium Hydroxide Solution*— 0.55*N*. Dissolve 11.00 g Sodium Hydroxide (NaOH ACS) in a 500 ml volumetric flask. Dilute to 500 ml with H₂O.

NOTE: To achieve the appropriate volume in the filter bags, the concentrations of the HCl and NaOH solutions were modified to accomplish the pH adjustment in a manner equivalent to the AOAC 985.29 and 2001.03 methods.

27. Appendix B – Analytical Procedures

IMPORTANT:

While infrequent, procedures may be updated with new information. For the most up-to-date procedure revision refer to: <https://www.ankom.com/analytical-methods-support/tdf-analyzer>.

TDF Method (AOAC 991.43/985.29/2001.03, AACC 32-07.01, NMKL 129,2003) using the ANKOM^{TDF} Dietary Fiber Analyzer

Definition- Using Filter Bag Technology, this method determines the amount of TDF within a given sample using the weight of the recovered TDF residue corrected for ash and protein content.

Scope- Total, Soluble, and Insoluble Dietary Fiber in Foods and Feeds

Apparatus

- Analytical Balance—capable of weighing 0.1 mg.
- Drying Oven—capable of maintaining a temperature of 105 ± 2°C.
- Fiber Recovery instrument capable of recovering TDF residue. The instrument must be capable of automatically adding all reagents, mixing the sample to ensure proper digestion, and controlling digestion and precipitation temperatures (ANKOM^{TDF} Dietary Fiber Analyzer, ANKOM Technology).
- Filter Bags (DF-S, DF-FT, ANKOM Technology).
- Bag Weigh Holder—used for eliminating static during the bag weighing process (TDF52, ANKOM Technology).
- Drying Rack—used for drying filter bags (TDF50, ANKOM Technology).
- Heat sealer—sufficient for sealing the filter bags closed (HS, ANKOM Technology).
- Desiccant Pouch—collapsible sealable pouch with desiccant inside that enables the removal of air from around the filter bags (*MoistureStop* weigh pouch, ANKOM Technology).
- Marking pen—solvent and acid resistant (F08, ANKOM Technology).
- Acetone rinse stand (TDF51 Rinse Stand, ANKOM Technology).
- Ashing Oven.
- Protein Determination equipment—Kjeldahl recommended.

Reagents

Use DI or DW Water throughout.

Solutions common to AOAC 991.43, 985.29, and 2001.03 methods

- Ethanol 95%.
- Ethanol 78%—Place 821 ml 95% ethanol into 1 L volumetric flask, dilute to volume with H₂O.
- Enzyme solutions—Make enzyme solutions according to the Enzyme Dilution Table below.

Enzyme	Dilute ANKOM concentrates (AOAC 991.43)
α-Amylase	TDF80 or TDF81: Dilute 5 ml to 25 ml with DI/DW water
Protease	TDF82 or TDF83: Dilute 5 ml to 25 ml with DI/DW water
Amyloglucosidase	TDF84 or TDF85: Dilute 5 ml to 25 ml with DI/DW water

Enzyme	Dilute ANKOM concentrates (AOAC 985.29)
α-Amylase	TDF80 or TDF81: Dilute 10ml to 25 ml with DI water
Protease	TDF82 or TDF83: Dilute 5 ml to 25 ml with DI water
Amyloglucosidase	TDF84 or TDF85: Dilute 5 ml to 25 ml with DI water

Enzyme	Make up Enzyme Solutions (AOAC 2001.03)
α-Amylase	300 ± 30 Ceralpha U/ml (in DI water)
Protease	600-990 Glycose U/ml (in DI water)
Amyloglucosidase	35-75 Tyrosine U/ml (in DI water)

(d) *Diatomaceous earth (DE)*—(ANKOM DE1, DE2, or equivalent).

(e) *Acetone*—reagent grade.

Solutions unique to the AOAC 991.43 method

- MES*—2-(*N*-Morpholino) ethanesulfonic acid (MES, ANKOM Technology, or equivalent).
- TRIS*—Tris(hydroxymethyl)aminomethane (TRIS, ANKOM Technology, or equivalent).
- MES-TRIS buffer solution*—0.05M MES, 0.05M TRIS, pH 8.2 at 24°C. Dissolve 19.52 g MES and 12.2 g TRIS in 1.7 L H₂O. Adjust pH to 8.2 with 6*N* NaOH and dilute to 2 L with H₂O. (*Note:* It is important to adjust pH to 8.2 at 24°C. However, if buffer temperature is 20°C, adjust pH to 8.3; if temperature is 28°C, adjust pH to 8.1. For deviations between 20 and 28°C, adjust by interpolation.)
- Hydrochloric acid solution*—0.561*N*. Dilute 93.5 ml of 6*N* HCl to 1 L with H₂O.

Solutions unique to the AOAC 985.29/2001.03 methods

- Hydrochloric acid solution (AOAC 985.29/2001.03)*—0.65*N*. Dilute 325 ml of 1*N* HCl to 500 ml with H₂O.
- Phosphate buffer solution*—0.08M, pH 6.0. Dissolve 1.40 g Sodium Phosphate dibasic, anhydrous (Na₂HPO₄) (or 1.75 g dihydrate) and 9.68 g Sodium Phosphate monobasic monohydrate (NaH₂PO₄) (or 10.94 g dihydrate) in a 1 L volumetric flask. Dilute to 1 L with H₂O. Adjust pH to 6.0.
- Sodium Hydroxide Solution*—0.55*N*. Dissolve 11.00 g Sodium Hydroxide (NaOH ACS) in a 500 ml volumetric flask. Dilute to 500 ml with H₂O.

Sample Preparation

- Grind samples in a centrifugal mill with a 0.5 mm screen. Samples ground finer may have particle loss from the filter bags and result in low values.
- De-fat and de-sugar samples as needed based on the AOAC 991.43/985.29/2001.03, AACC 32-07.01, or NMKL 129,2003 methods. Adjust sample weights accordingly.

TDF Procedure (see the TDF Analysis sections of the Operator's Manual for more detail)

- Label the filter bags using a solvent resistant marker.
- Fill all chemical containers to the Min. Level line or above.
- Fill all enzyme containers to the 15 ml line or above.
- Place each filter bag in a tared Bag Weigh Holder and record the weight.
- Place ca 1 g of DE in each of six tared and numbered tins and record the weights.

6. Place 0.5±0.05 g of sample in each of six tared and numbered tins and record the weights.
7. Remove all Clamp Bars from the instrument.
8. Follow the instructions on the Touch Screen Display (as detailed in steps 9-25 below).
9. Install SDF bags by gently pulling the black SDF Delivery Nozzle toward you and pulling the bag up underneath the nozzle. Pull the bag up so that the top of the bag is about 35 mm (1.375 inches) above the top of Clamp Bar C and return the nozzle to its original position to hold the bag in place. Center each bag within the black lines located on the back of Clamp Bar C.
10. Re-install Clamp Bar D.
11. Flatten the bag to remove any wrinkles.
12. Press the check mark button (☑) on the "SDF Bags (and clamp bar D) installed?" screen on the Touch Screen Display. This will close bar D which will pinch the bags just above the filter.
13. Add DE to each SDF bag, rinsing the tin with no more than 3 ml of 78% to ensure complete transfer and that all the DE is below the SDF Delivery Nozzle.
14. Install IDF *Flow-Thru* bags by gently pulling the black IDF Delivery Nozzle toward you and pulling the bag up underneath the nozzle. Pull the bag up so that the top of the bag is about 35 mm (1.375 inches) above the top of Clamp Bar A and return the nozzle to its original position to hold the bag in place. Center each bag within the black lines located on the back of Clamp Bar A.
15. Place at least 20 mm (0.75 inches) of the bottom of each IDF *Flow-Thru* bag inside the top of each corresponding SDF bag.
16. Re-install Clamp Bar B.
17. Flatten the bag to remove any wrinkles.
18. Press the check mark button (☑) on the "IDF Bags (and clamp bar B) installed?" screen on the Touch Screen Display. This will close bar B which will pinch the bags just above the filter.
19. Re-install Clamp Bar C.
20. Add sample into each of the IDF *Flow-Thru* bags. Rinse the tin with no more than 3 ml of DI or DW water to ensure complete transfer and that all the sample is below the IDF Delivery Nozzle.
21. Secure the front of each SDF filter bag in place with the hook located on the front part of Clamp Bar C.
22. Check that the Nitrogen supply is connected to the instrument and turned on.
23. Set Filter Times.
24. Set the manual pH check.
25. Press the START button to begin the automated processes.
26. AOAC 985.29 ONLY: Once the buffer had been added in the beginning of the run, the user can manually check and adjust pH to 6.0 ± 0.2 by doing the following:
 - Open clamp bar A (manually press green button below touch screen).
 - Measure and adjust pH using a probe that can easily be rinsed (with DI or DW Water). If you add acid or base to adjust the pH, you must mix the solution to get an accurate pH reading. Manually mix the solution by pressing the outside of the bag, with your fingers, just above clamp bar B, multiple times
 - Close clamp bar A.
27. **AOAC 985.29/2001.03 ONLY:** Check the pH during the IDF process before the Protease digestion. The Touch Screen Display will remind you to do this. Adjust to 7.3-7.7.
28. Check the pH during the IDF process, after the HCl has been added. (If configured, the instrument will stop so you can make this check.) Adjust to 4.0-4.7 (AOAC 991.43) or 4.0-4.6 (AOAC 985.29/2001.03) as needed.
29. After the automated processes are complete, rinse the SDF bags twice with acetone. ANKOM recommends the use of the ANKOM TDF51 Rinse Stand for the acetone rinses.
30. After the acetone has evaporated, with your Heat Sealer set between 3 and 4 (settings may vary depending on the heat sealer and the power source), press the Heat Sealer arm down for 3 to 4 seconds to seal each bag just above the filter. This keeps all residue contained to the filter area while handling the bags.
31. Place each filter bag in the Drying Rack and place the rack in an oven set to 105°C. Dry to constant weight (about 90 minutes).
32. Remove all of the bags from the oven and place them in a desiccant pouch to cool.
33. Remove each bag one at a time and record their weights.
34. Determine the protein content within the TDF residue. See the "Protein Determination Procedure – SDF / TDF" for more information.
35. Determine the ash content within the TDF residue. See the "Ash Determination Procedure – IDF / SDF / TDF" for more information.
36. Calculate the % TDF value.

Calculations (all weights in grams)

$$\% \text{ TDF} = \frac{[(R_1 + R_2)/2] - P - A - B}{(M_1 + M_2)/2} \times 100$$

$$= \frac{[\{(f_{F1} - f_{S1} - D_1) + (f_{F2} - f_{S2} - D_2)\}/2] - P - (A_2 - D_2) - B}{(M_1 + M_2)/2} \times 100$$

Where :

M₁,M₂ = Original wt for duplicate samples adjusted for pre-treatment fat and sugar losses (g)

R₁,R₂ = Residue for duplicate samples (g)

f_F = Final Filter Bag (g)

f_S = Initial Filter Bag (g)

D = Original wt of Diatomaceous Earth (g)

P = Protein of residue and bag (g)

A = Ash of residue and bag (g)

B = Blank (g)

= [(BR₁ + BR₂)/2] - P_B - (A_B - D_B)

= [\{(f_{BF1} - f_{BS1} - D_{B1}) + (f_{BF2} - f_{BS2} - D_{B2})\}/2] - P_{B1} - (A_{B2} - D_{B2})

BR₁,BR₂ = Residue for duplicate blanks (g)

f_{BF} = Final Blank Filter Bag (g)

f_{BS} = Initial Blank Filter Bag (g)

P_B = Protein of Blank Filter Bag (g)

A_B = Ash of Blank Filter Bag (g)

D_B = Original wt of Diatomaceous Earth in Blank Filter Bag (g)

IDF/SDF Method (AOAC 991.43, AACC 32-07.01, NMKL 129,2003) using the ANKOM^{TDF} Dietary Fiber Analyzer

Definition- Using Filter Bag Technology, this method determines the amount of IDF, SDF, and TDF within a given sample using the weight of the recovered IDF and SDF residue corrected for ash and protein content.

Scope- Total, Soluble, and Insoluble Dietary Fiber in Foods and Feeds

Apparatus

1. Analytical Balance—capable of weighing 0.1 mg.
2. Drying Oven—capable of maintaining a temperature of $105 \pm 2^\circ\text{C}$.
3. Fiber Recovery instrument capable of separately recovering IDF and SDF residue. The instrument must be capable of automatically adding all reagents, mixing the sample to ensure proper digestion, and controlling digestion and precipitation temperatures (ANKOM^{TDF} Dietary Fiber Analyzer, ANKOM Technology).
4. Filter Bags (DF-I, DF-S, ANKOM Technology).
5. Bag Weigh Holder—used for eliminating static during the bag weighing process (TDF52, ANKOM Technology).
6. Drying Rack—used for drying filter bags (TDF50, ANKOM Technology).
7. Heat sealer—sufficient for sealing the filter bags closed (HS, ANKOM Technology).
8. Desiccant Pouch—collapsible sealable pouch with desiccant inside that enables the removal of air from around the filter bags (*MoistureStop* weigh pouch, ANKOM Technology).
9. Marking pen—solvent and acid resistant (F08, ANKOM Technology).
10. Acetone rinse stand (TDF51 Rinse Stand, ANKOM Technology).
11. Ashing Oven.
12. Protein Determination equipment—Kjeldahl recommended.

Reagents

Use DI or DW Water throughout.

- (a) *Ethanol* 95%.
- (b) *Ethanol* 78%—Place 821 ml 95% ethanol into 1 L volumetric flask, dilute to volume with H₂O.
- (c) *Enzyme solutions*—Make enzyme solutions according to the Enzyme Dilution Table below.

Enzyme	Dilute ANKOM concentrates (AOAC 991.43)
α -Amylase	TDF80 or TDF81: Dilute 5 ml to 25 ml with DI/DW water
Protease	TDF82 or TDF83: Dilute 5 ml to 25 ml with DI/DW water
Amyloglucosidase	TDF84 or TDF85: Dilute 5 ml to 25 ml with DI/DW water

Enzyme	Dilute ANKOM concentrates (AOAC 985.29)
α -Amylase	TDF80 or TDF81: Dilute 10 ml to 25 ml with DI/DW water
Protease	TDF82 or TDF83: Dilute 5 ml to 25 ml with DI/DW water
Amyloglucosidase	TDF84 or TDF85: Dilute 5 ml to 25 ml with DI/DW water

Enzyme	Make up Enzyme Solutions (AOAC 2001.03)
α -Amylase	300 \pm 30 Ceralpha U/ml (in DI/DW water)
Protease	600-990 Glycose U/ml (in DI/DW water)
Amyloglucosidase	35-75 Tyrosine U/ml (in DI/DW water)

- (d) *Diatomaceous earth (DE)*—(ANKOM DE1, DE2, or equivalent).
- (e) *Acetone*—reagent grade.
- (f) *MES*—2-(*N*-Morpholino) ethanesulfonic acid (MES, ANKOM Technology, or equivalent).
- (g) *TRIS*—Tris(hydroxymethyl)aminomethane (TRIS, ANKOM Technology, or equivalent).

- (h) *MES-TRIS buffer solution*—0.05M MES, 0.05M TRIS, pH 8.2 at 24°C. Dissolve 19.52 g MES and 12.2 g TRIS in 1.7 L H₂O. Adjust pH to 8.2 with 6*N* NaOH and dilute to 2 L with H₂O. (*Note:* It is important to adjust pH to 8.2 at 24°C. However, if buffer temperature is 20°C, adjust pH to 8.3; if temperature is 28°C, adjust pH to 8.1. For deviations between 20 and 28°C, adjust by interpolation.)
- (i) *Hydrochloric acid solution*—0.561*N*. Dilute 93.5 ml of 6*N* HCl to 1 L with H₂O.

Sample Preparation

1. Grind samples in a centrifugal mill with a 0.5 mm screen. Samples ground finer may have particle loss from the filter bags and result in low values.
2. De-fat and de-sugar samples as needed based on the AOAC 991.43, AACC 32-07.01, or NMKL 129,2003 methods. Adjust sample weights accordingly.

IDF/SDF Procedure (see the *IDF/SDF Analysis* section of the *Operator's Manual* for more detail)

1. Label the filter bags using a solvent resistant marker.
2. Fill chemical containers to the Min. Level line or above.
3. Fill all enzyme containers to the 15 ml line or above.
4. Place each filter bag in a tared Bag Weigh Holder and record the weight.
5. Place ca 1 g of DE in each of six tared and numbered tins and record the weights.
6. Place 0.5 \pm 0.05 g of sample in each of six tared and numbered tins and record the weights.
7. Remove all Clamp Bars from the instrument.
8. Follow the instructions on the Touch Screen Display (as detailed in steps 9-25 below).
9. Install SDF bags by gently pulling the black SDF Delivery Nozzle toward you and pulling each bag up so that the nozzle is inside the bag. Pull the bag up so that the top of the bag is about 35 mm (1.375 inches) above the top of Clamp Bar C and return the nozzle to its original position to hold the bag in place. Center each bag within the black lines located on the back of Clamp Bar C.
10. Re-install Clamp Bar D.
11. Flatten the bags to remove any wrinkles.
12. Press the check mark button () on the "SDF Bags (and clamp bar D) installed?" screen on the Touch Screen Display. This will close bar D which will pinch the bags just above the filter.
13. Add DE to each SDF bag, rinsing the tin with no more than 3 ml of 78% to ensure complete transfer and that all the DE is below the SDF Delivery Nozzle.
14. Install IDF bags by gently pulling the black IDF Delivery Nozzle toward you and pulling each bag up underneath the nozzle. Pull the bag up so that the top of the filter part of the IDF bag is just below the bottom of Clamp Bar B and return the nozzle to its original position to hold the bag in place. Center each bag within the black lines located on the back of Clamp Bar A.

Calculations (all weights in grams)

$$\% \text{ IDF} = \left[\frac{[(R_1 + R_2)/2] - P - A - B}{(M_1 + M_2)/2} \right] \times 100$$

$$= \left[\frac{[(f_{F1} - f_{S1}) + (f_{F2} - f_{S2})]/2 - P - A - B}{(M_1 + M_2)/2} \right] \times 100$$

Where:

- M_1, M_2 = Original wt for duplicate samples adjusted for pre-treatment fat and sugar losses (g)
- R_1, R_2 = Residue for duplicate samples (g)
- f_f = Final Filter Bag (g)
- f_s = Initial Filter Bag (g)
- P = Protein of residue and bag (g)
- A = Ash of residue and bag (g)
- B = Blank (g)
- B = $[(BR_1 + BR_2)/2] - P_B - A_B$
- B = $[(f_{BF1} - f_{BS1}) + (f_{BF2} - f_{BS2})]/2 - P_B - A_B$
- BR_1, BR_2 = Residue for duplicate blanks (g)
- f_{BF} = Final Blank Filter Bag (g)
- f_{BS} = Initial Blank Filter Bag (g)
- P_B = Protein of Blank Filter Bag (g)
- A_B = Ash of Blank Filter Bag (g)

$$\% \text{ SDF} = \left[\frac{[(R_1 + R_2)/2] - P - A - B}{(M_1 + M_2)/2} \right] \times 100$$

$$= \left[\frac{[(f_{F1} - f_{S1} - D_1) + (f_{F2} - f_{S2} - D_2)]/2 - P - (A_2 - D_2) - B}{(M_1 + M_2)/2} \right] \times 100$$

Where:

- M_1, M_2 = Original wt for duplicate samples adjusted for pre-treatment fat and sugar losses (g)
- R_1, R_2 = Residue for duplicate samples (g)
- f_f = Final Filter Bag (g)
- f_s = Initial Filter Bag (g)
- D = Original wt of Diatomaceous Earth (g)
- P = Protein of residue and bag (g)
- A = Ash of residue and bag (g)
- B = Blank (g)
- B = $[(BR_1 + BR_2)/2] - P_B - (A_B - D_B)$
- B = $[(f_{BF1} - f_{BS1} - D_{B1}) + (f_{BF2} - f_{BS2} - D_{B2})]/2 - P_{B1} - (A_{B2} - D_{B2})$
- BR_1, BR_2 = Residue for duplicate blanks (g)
- f_{BF} = Final Blank Filter Bag (g)
- f_{BS} = Initial Blank Filter Bag (g)
- P_B = Protein of Blank Filter Bag (g)
- A_B = Ash of Blank Filter Bag (g)
- D_B = Original wt of Diatomaceous Earth in Blank Filter Bag (g)

$$\% \text{ TDF} = \% \text{ IDF} + \% \text{ SDF}$$

IDF/SDF Procedure (continued)

15. Place at least 20 mm (0.75 inches) of each IDF bag filter inside the top of each corresponding SDF bag.
16. Re-install Clamp Bar B.
17. Flatten the bags to remove any wrinkles.
18. Press the check mark button (☑) on the "IDF Bags (and clamp bar B) installed?" screen on the Touch Screen Display. This will close bar B which will pinch the bags just above the filter.
19. Re-install Clamp Bar C.
20. Add sample into each of the IDF bags. Rinse the tin with no more than 3 ml of DI or DW water to ensure complete transfer and that all the sample is below the IDF Delivery Nozzle.
21. Secure the front of each SDF filter bag in place with the hook located on the front part of Clamp Bar C.
22. Check that the Nitrogen supply is connected to the instrument and turned on.
23. Set Filter Times.
24. Set the manual pH check.
25. Press the START button to begin the automated processes.
26. Check the pH during the IDF process, after the HCl has been added. (If configured, the instrument will stop so you can make this check.) Adjust to 4.0-4.7 as needed.
27. After the automated processes are complete, rinse the IDF and SDF bags twice with acetone. ANKOM recommends the use of the ANKOM TDF51 Rinse Stand for the acetone rinses.
28. After the acetone has evaporated, with your Heat Sealer set between 3 and 4 (settings may vary depending on the heat sealer and the power source), press the Heat Sealer arm down for 3 to 4 seconds to seal each bag just above the filter. This keeps all residue contained to the filter area while handling the bags.
29. Place each bag in the Drying Rack and place the rack in an oven set to 105°C. Dry to constant weight (about 90 min).
30. Remove all of the bags from the oven and place them in desiccant pouches to cool.
31. Removing only one filter bag from the desiccant pouches at a time, place each filter bag in a tared Bag Weigh Holder and record the weights.
32. Determine the protein content within the IDF residue. See the "Protein Determination Procedure – IDF" for more information.
33. Determine the protein content within the SDF residue. See the "Protein Determination Procedure – SDF / TDF" for more information.
34. Determine the ash content within the IDF and SDF residue. See the "Ash Determination Procedure – IDF / SDF / TDF" for more information.
35. Calculate the % IDF and % SDF values.
36. Calculate % TDF by adding the % IDF and % SDF values.

28. Appendix C – Line Flushing Procedure

The fluid delivery lines can become obstructed if they are not flushed regularly. For instruments being used on a frequent basis, monthly flushes are sufficient to prevent blockages (or, for more optimal performance, once a week). It is important to note that, BEFORE an instrument is left unused for one week or longer, the Line Flushing Procedure must be completed prior to non-use/storage.

28.1. Flush and purge the lines.

- 28.1.1. With the instrument turned on, press the **Diagnostics** button on the Touch Screen Display.
- 28.1.2. Press the **Line Charge** button on the Touch Screen Display. The following screen will be displayed.

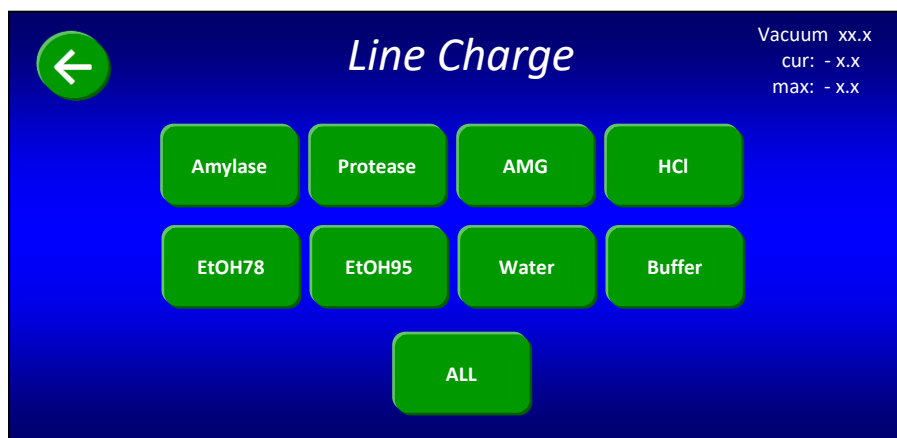

- 28.1.3. Obtain the TDF70 Line Flush Tubing Assembly shown below. Note the nine connection points on the Tubing Assembly.

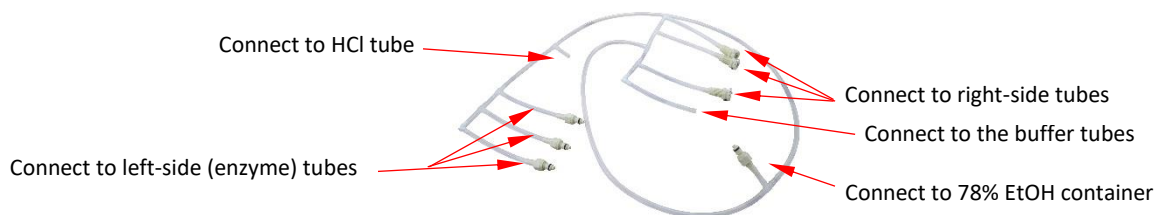

- 28.1.4. Remove the enzyme containers on the left side of the instrument. Disconnect the HCl container. Store or dispose of fluids properly. Attach the three connectors on left side of the Line Flush Tubing Assembly to the Enzyme lines. Also connect the short tube (with no connector) to the barbed fitting on the black HCL line. Also, connect the fitting at the middle of the Tubing Assembly to the 78% Ethanol Container.

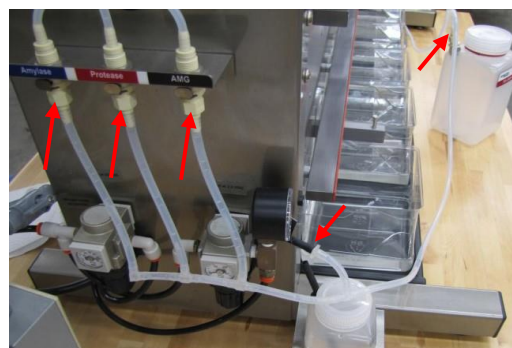

28.1.5. Disconnect the tubing connectors on the right side of the instrument from the EtOH78, EtOH95, Water and Buffer containers. Store or dispose of the fluids properly. Attach the four connectors on the Line Flush Tubing Assembly to the EtOH95%, EtOH78%, Buffer and Deionized Water connectors.

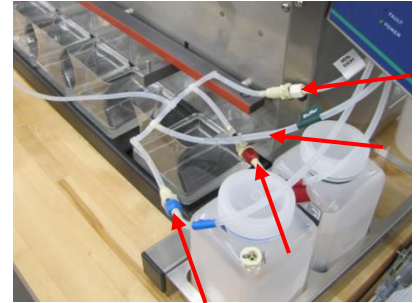

28.1.6. Fill the 78% Ethanol Container with 220 mls of 78% Ethanol.



28.1.7. On the touch screen in the “Line Charge” screen, press the HCL button. This will draw 78% Ethanol into the HCL line.

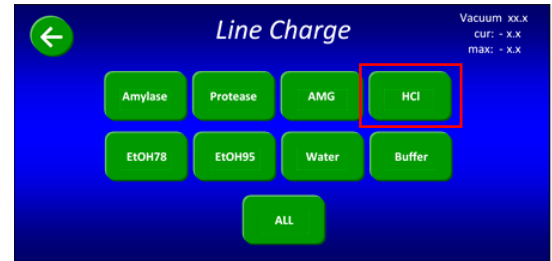

28.1.8. Next, on the same screen, press the “ALL” button. This will draw 78% alcohol into each of the lines, one at a time. Do this a second time to ensure a thorough flush of 78% Ethanol through the lines. This process will drain or nearly drain the 78% Ethanol Container.

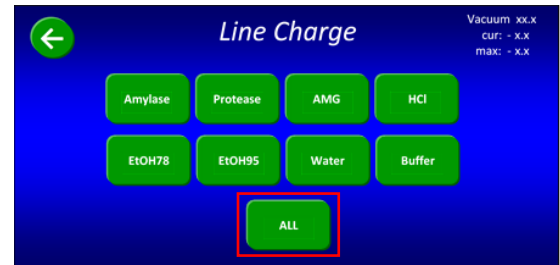

28.1.9. Repeat the Line Charge “ALL” two more times to purge the Ethanol from the lines by sucking air into them. At the end of the second line charge with an empty container, there should be minimal fluid remaining in the lines. If a significant amount of fluid is observed, repeat the line charge “ALL” until lines are mostly cleared. During the line charge you should no longer see ethanol being pumped out to waste. See arrow in picture identifying waste lines. The TDF Instrument fluid lines have now been flushed and purged, and the TDF Instrument is ready for continued use or a period of non-use/ storage.

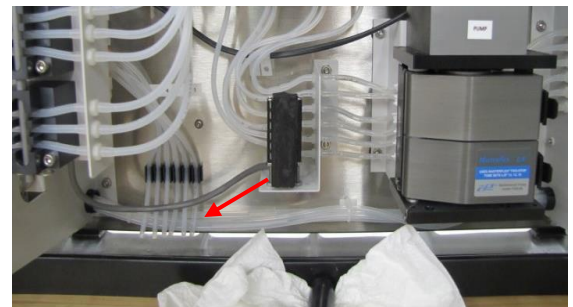





29. Appendix D – Accessories (sold separately)

Contact ANKOM Technology or an authorized dealer to order accessories.

<p>TDF51 – Rinse Stand assy</p> 	<p>DE1/DE2 – Diatomaceous Earth (DE)</p> 	<p>HS – Heat Sealer (120v) HSi – Heat Sealer (220v)</p> 
<p>DF-S – SDF Filter Bags (50)</p> 	<p>DF-I – IDF Filter Bags (50)</p> 	<p>DF-FT – Flow-thru Filter Bags (100)</p> 
<p>TDF81 – α-Amylase (100 ml)</p> 	<p>TDF83 – Protease (100 ml)</p> 	<p>TDF85 – Amyloglucosidase (100 ml)</p> 
<p>TDF80 – α-Amylase (20 ml)</p> 	<p>TDF82 – Protease (20 ml)</p> 	<p>TDF84 – Amyloglucosidase (20 ml)</p> 
<p>8500 – Total Dietary Fiber Assay Kit (100 Assays per kit) (RINTDF)</p> 	<p>TDF72 – Codex Method Upgrade Kit (with Registration Code)</p> <div style="display: flex; justify-content: space-around;"> <div data-bbox="678 1360 1003 1545"> <p>1 – Amylase/AMG Container (TDF57)</p>  </div> <div data-bbox="1117 1360 1419 1545"> <p>1 – Trizma Base Container (TDF58)</p>  </div> </div>	
<p>TDF97 -- Glass Filtrate Cup</p> 	<div style="display: flex; justify-content: space-around;"> <div data-bbox="667 1556 959 1835"> <p>1 – Acetic Acid Container (TDF59) & Fluid Tube Label</p>  </div> <div data-bbox="1068 1556 1468 1835"> <p>1 – Sodium Maleate Buffer Container (TDF39) & Fluid Tube Label</p>  </div> </div>	

Automation saves time and money!

ANKOM Technology is an international company with products that include...

	<p>DELTA Fiber Analyzer</p> <ul style="list-style-type: none">• Crude Fiber (AOCS Ba 6a-05), ADF, NDF• An internal pump system allows the user to connect to and draw from any chemical source within range of the instrument, eliminating the need to lift heavy cubetainers.• Batch process up to 24 samples at one time
	<p>FLEX Analyte Extractor</p> <ul style="list-style-type: none">• Vitamin Analysis - Automatic saponification, extraction, and evaporation of solvent in one instrument• Eliminates bi-phase extractions• State-of-the-art software allows method adjustment and customization
	<p>XT15 Fat Extractor</p> <ul style="list-style-type: none">• Official Method AOCS Am 5-04• Fully automatic• Solvent recovery at 97% or greater• Batch process - up to 15 samples at one time
	<p>RF Gas Production System</p> <ul style="list-style-type: none">• High sensitivity pressure measurement• Applications include: Biomass-to-Energy analysis (e.g., Ethanol, methane, etc.), Biodegradability, Ruminant Nutrition, Yeast Activity, Beer/Wine Fermentation, Soil respiration, BOD, Human Digestion, etc.• Wireless Computer control and data storage
	<p>Chemicals</p> <ul style="list-style-type: none">• A wide variety of chemicals used for many different lab operations• Pre-mixed solutions available

Please visit our web site at www.ankom.com for more information.

2052 O'Neil Rd, Macedon NY 14502
Telephone: (315) 986-8090
Fax: (315) 986-8091
www.ankom.com

ANKOM
TECHNOLOGY