



This page intentionally left blank

# Table of Contents

Introduction .....	5
Warranty .....	5
Filter Bags .....	5
Operating Environment .....	5
Contact Information .....	6
Instrument Description .....	7
Safety Precautions .....	8
Instrument Installation and First Run .....	9
Fat Extraction Calculations .....	13
Fat Extraction Support Items .....	14
Sample Preparation .....	15
Fat Extraction step-by-step procedure using the ANKOM <sup>XT10</sup> .....	21
Periodic Maintenance .....	25
Troubleshooting & Replacement Parts .....	27
Diagnostics .....	29
Appendix A - Analytical Procedure .....	33
Appendix B – Electrical Diagram .....	35

This page intentionally left blank

## Introduction

ANKOM Technology designs, manufactures, and markets instruments and support products used by analytical laboratories around the world in the environmental, agricultural, biomass, and food industries. ANKOM Technology can provide you with products for determining or monitoring dietary fiber, detergent fiber, fat, digestibility, microbial fermentation (anaerobic or aerobic) and more.

Committed to Total Customer Satisfaction, ANKOM designs every product based on a thorough assessment of customer needs.

Congratulations on your purchase of the ANKOM<sup>XT10</sup> Extraction System. We are confident that this product will effectively serve your needs.

The ANKOM<sup>XT10</sup> Extraction System was designed to automate the process of fat extraction. This reduces technician variation, increasing precision. By carefully following the operating instructions in this manual you will understand the details of sample and filter bag handling as well as the instrument controls, helping you to achieve the best possible results.

<b>NOTE:</b> Please review the entire contents of this manual before you begin operating this product.
--

## Warranty

ANKOM Technology warrants the ANKOM<sup>XT10</sup> Extraction System against any defects due to faulty workmanship or material for one year after the original date of purchase. This warranty does not include damage to the instrument resulting from neglect or misuse. During the warranty period, should any failure result from defects in workmanship or materials ANKOM Technology will, at its discretion, repair or replace the instrument free of charge.

Extended warranties are available upon request.

## Filter Bags

Use only ANKOM Technology filter bags (part # XT4) in your ANKOM<sup>XT10</sup> Extraction System. Use of any other filter mechanism will void the warranty. Filter bags can be purchased from ANKOM Technology or from your local authorized ANKOM distributor.

## Operating Environment

Your ANKOM<sup>XT10</sup> Extraction System is designed to operate within the following environments:

- Ambient Temperature Range: 15°–35°C
- Power: 100V–120V ~ 50/60Hz 10A  
220V–240V ~ 50/60Hz 5A

## Contact Information

At ANKOM Technology we are committed to your total satisfaction and therefore always available to help you get the most from your ANKOM products. We are also very interested in any comments or suggestions you may have to help us improve.

For any questions or suggestions regarding your instrument, please contact us at:

For Sales Support: sales@ankom.com or <https://www.ankom.com/contact-us>

For Technical Support: [www.ankom.com/contact/technical-services](http://www.ankom.com/contact/technical-services)

For Analytical Support: [www.ankom.com/contact/analytical-services](http://www.ankom.com/contact/analytical-services)

Telephone: (315) 986-8090

Fax: (315) 986-8091

## Instrument Description

### General Description

The ANKOM<sup>XT10</sup> Extraction System is designed to extract Crude (Free) Fat using conventional solvents, typically petroleum ether. The compounds extracted are primarily triacylglycerols together with a small quantity of related lipids, traditionally termed "Crude Fat." The analysis is achieved by measuring the loss of mass due to the extraction of fat/oil from the sample encapsulated in a filter bag. The quantitative isolation of the sample is accomplished by surrounding the sample in a sealed filter bag with a filtering capacity in the 2 - 3  $\mu\text{m}$  range. The filter bag has sufficient porosity to permit rapid solvent passage and is composed of polymeric material that is resistant to the higher temperatures and solvents used in the instrument.

The quantitative isolation achieved by the filter bag permits the ANKOM<sup>XT10</sup> Extraction System to automatically process samples in batches of up to 15. Simply place filter bags with sample in the PTFE Cup, add solvent to the Extraction Vessel, place the PTFE Cup on top of the solvent in the Extraction Vessel, lock the vessel in place, select the extraction time and temperature, and press "Start." The instrument will automatically extract the fat from the samples and recover the solvent from the Extraction Vessel when the operation is complete.

Below is a detailed view of the ANKOM<sup>XT10</sup> Extraction System.

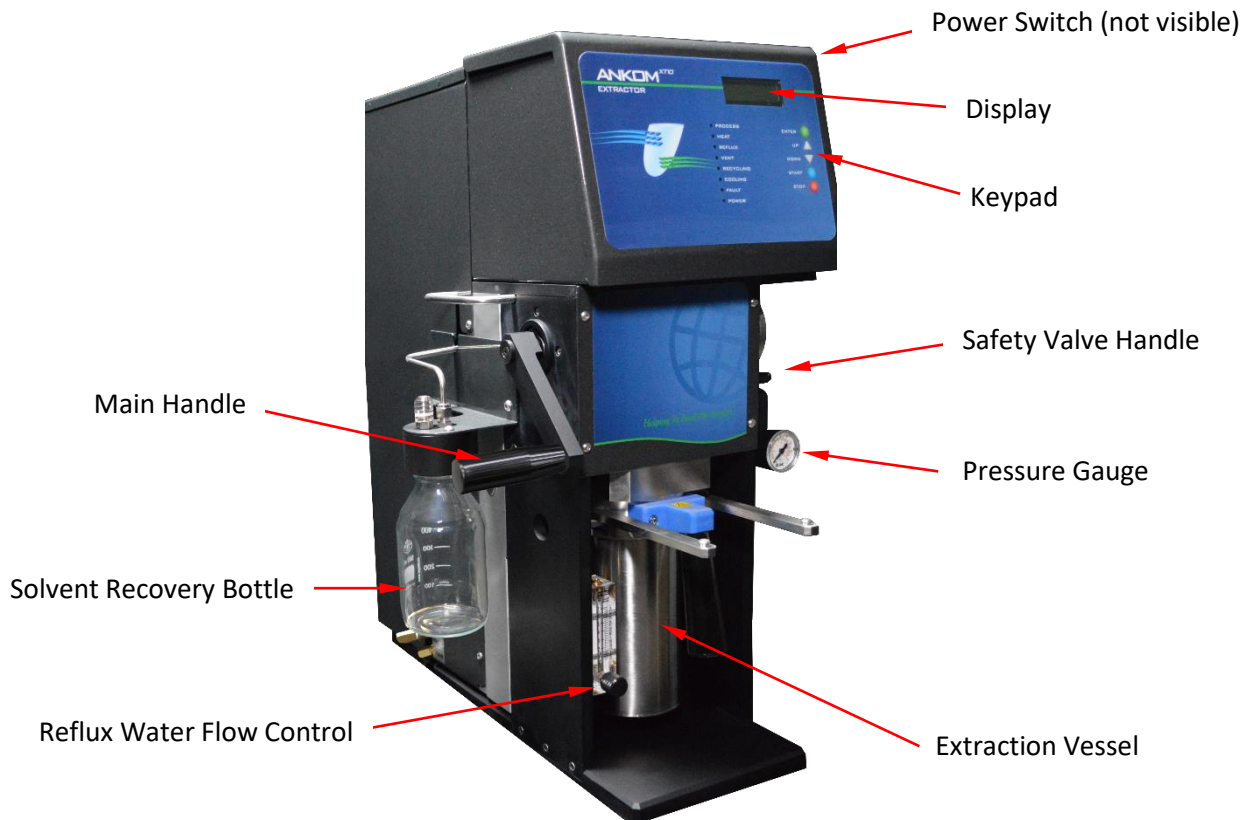

**NOTE:**

The **Reflux Water Flow Control** measures and controls the flow of water through the condenser to rapidly cool the solvent vapors during the extraction process. The proper water flow is set at the manufacturer. Contact ANKOM at [service@ankom.com](mailto:service@ankom.com) if the flow measurement is incorrect.

## Safety Precautions



**Flammable Hazard:** Static electricity is to be avoided as it is a spark hazard.

**Hot Surfaces:** Do not touch the extraction vessel during operation. The surface can exceed 70°C (158°F). **Failure to observe this caution may result in injury.**

**Hazardous Voltages:** Do not operate the instrument with the electrical compartment open. Hazardous voltages are present during operation. **Failure to observe this caution may result in electrical shock or electrocution.**

**Hazardous Materials:** When adding solvents, follow fill instructions completely to avoid fire and/or explosion. Waste material will contain small amounts of volatile solvents. Use caution when discarding. Follow safe laboratory practices according to both local and federal regulations when installing this instrument and when handling any organic solvents.

**WARNING:** Attempts to override safety features or to use this instrument in a manner not specified by ANKOM Technology voids the warranty and may result in serious injury or even death.

**This system is designed to meet and/or exceed the applicable standards of CE, CSA, NRTL and OSHA.**

**NOTE:**

Please review the entire contents of this manual before you begin operating this instrument.



## Instrument Installation and First Run

### Site Requirements

To install and operate the ANKOM<sup>XT10</sup> Extraction System you will need the following:

- Adjustable wrench
- Chilled or tap water supply not to exceed 23°C
- Adequate power (see “Operating Environment” section)
- Drain
- Vent Hood

### Instrument Installation Procedure

To install the ANKOM<sup>XT10</sup> Extraction System, follow the procedure detailed below.

1. Remove the instrument from the shipping container and place it on a smooth level surface in an area that is free of dust and excessive moisture and is within 6 ft. of a drain and cold water supply.
2. Place the instrument either in a Vent Hood or within 6 ft. of one.

**NOTE:** The user is responsible for determining if venting of this instrument requires placement in a hood. Please follow both local and federal regulations when installing this instrument.

3. Connect the tube from the top fitting to the water supply.
4. Connect the tube from the bottom fitting to the drain.
5. Connect the Solvent Recovery Bottle to the instrument.

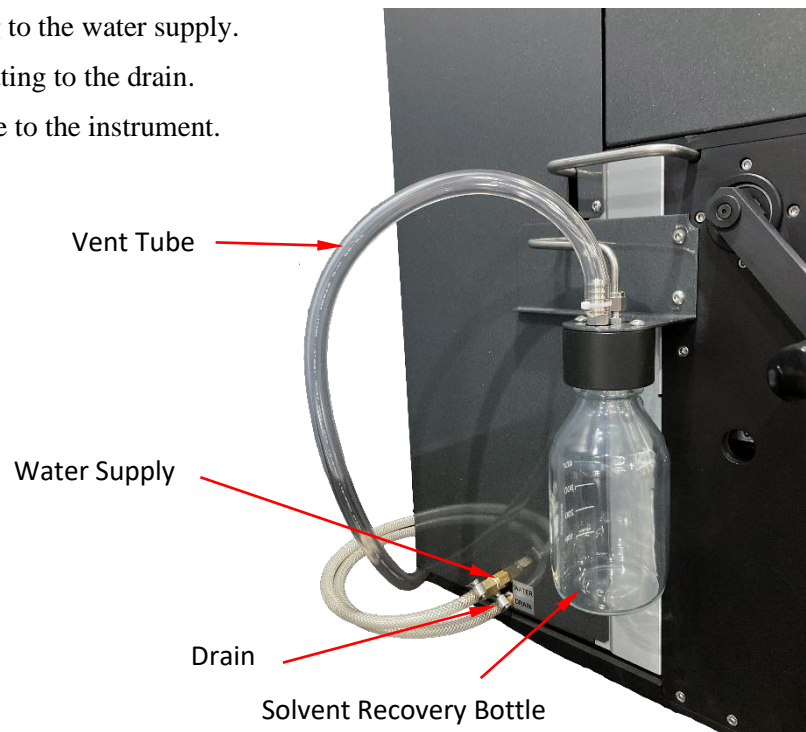

**NOTE:** Ensure that there are no kinks or bends in any of the tubing connected to the instrument.

6. Plug the power cord into a grounded receptacle.

7. To complete the installation, run the instrument (without samples) according to the procedure below.

**7.1 Turn the instrument power ON.**

The Display will briefly show the software version number followed by the screen to the right.

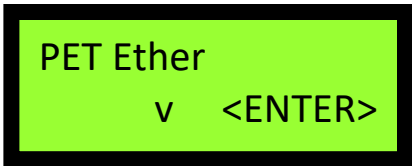

**NOTE:** The factory default solvent shown on the Display is "Pet Ether." However, the instrument computer will store in memory the last solvent selection made and use it as the default solvent shown on the Display screen every time the instrument is ready for a new run.

**7.2 Select the solvent you want to use.**

7.2.1 Press the Down Arrow (v) key on the Keypad until the desired solvent is shown on the Display.

**NOTE:** If using diethyl ether or a solvent mixture that includes diethyl ether (such as the Mojonnier solution mixture), you will need the O-ring Kit for High Penetration Solvents (part # X95) to replace the standard O-rings on the top of the Extraction Vessel and the Valve Kit for High Penetration Solvents (part # X73).

 **Warning:** Do NOT use Acetone in this instrument because it will cause damage to the valves.

7.2.2 Press ENTER on the Keypad to complete the solvent selection.

The Display should now show the screen to the right.

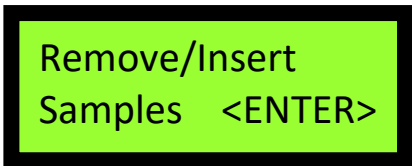

**7.3 Check that the Extraction Vessel is properly installed in the instrument.**

7.3.1 Press down the Safety Valve Handle to release the Safety Valve Pin and rotate the Main Handle upward until it stops.



7.3.2 Use the Extraction Vessel Handle to pull the Extraction Vessel out.



7.3.3 Press ENTER on the Keypad.

The Display should now show the screen to the right.

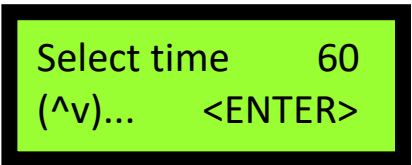

**7.4 Set the Extraction Time.**

7.4.1 Using the arrow keys on the Keypad, set the Extraction time to 20 minutes for the initial run. (*The recommended time is 60 minutes.*)

7.4.2 Press ENTER on the Keypad to set the Time.

The Display should now show the screen to the right.  
(The temperature shown will be the last temperature entered.)

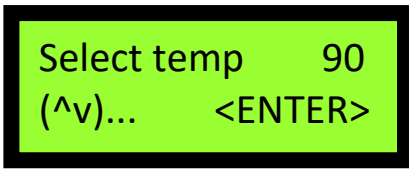

**7.5 Set the Extraction Temperature.**

7.5.1 Using the arrow keys on the Keypad, select the desired Extraction Temperature. (The recommended maximum temperature is 90°C.)

7.5.2 Press ENTER on the Keypad to set the Temperature.

The Display should now show the screen to the right.

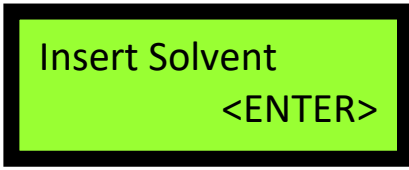

**7.6 Remove the white PTFE Insert from the Extraction Vessel.**



**7.7 Insert solvent into the Extraction Vessel.**

7.7.1 Ensure that the Extraction vessel is cool.

7.7.2 Pour 350ml of solvent directly into the empty Extraction Vessel.



**7.8 Put the PTFE Insert into the Extraction Vessel and the Extraction Vessel into the instrument.**

7.8.1 Align the PTFE Insert slot with the Extraction Vessel pin.

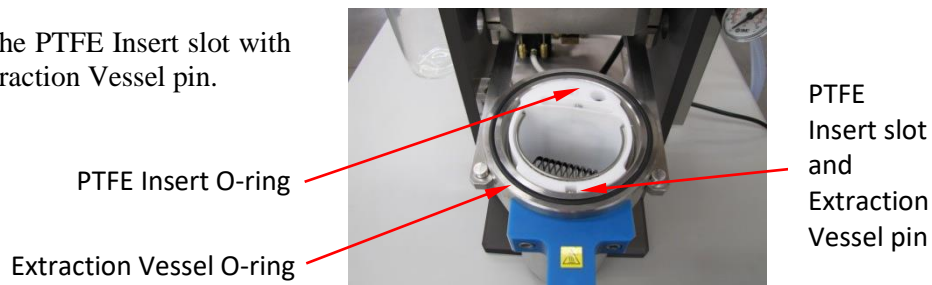

**IMPORTANT:**

- The PTFE Insert O-ring and the Extraction Vessel O-ring must be in place before running the instrument.
- The PTFE Insert slot must be aligned with the Extraction Vessel pin before running the instrument.

7.8.2 Slide the Extraction Vessel into the instrument ensuring the Extraction Vessel O-ring stays in place.

7.8.3 Press ENTER on the Keypad.

The Display should now show the screen to the right.

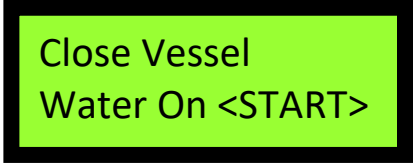

7.8.4 Pull the Main Handle downward, closing and locking the Extraction Vessel in place. You will hear a click noise when the Safety Valve Pin locks in place.



**IMPORTANT:** Before running the instrument, verify that the Extraction Vessel is locked in place by attempting to rotate the Main Handle upward. If it is not locked, repeat step 7.8.4 above.

**7.9 Verify that the water supply is on.**

**7.10 Run the instrument.**

Press START on the Keypad.

The instrument will run through its automatic operation, showing on the Display a time countdown along with process information.

7.10.1 For future reference, record the countdown time on the screen when the heat reaches 90°C.

7.10.2 After the instrument reaches 90°C, record the reflux water flow in the flow controller. The value should be between 6 and 7 GPH (4 to 6 GPH if using a chiller). If necessary, turn the front knob on the controller counterclockwise to increase the value, and clockwise to decrease the value. The reflux process runs on 90 second cycles. The reflux controller must be read and adjusted during the first 1 minute of the cycle.



7.10.3 Verify that the XT10 runs through the drain sequence with no errors.

When the instrument has completed its automatic operation, the Display will show the screen to the right.

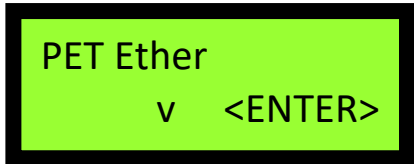

**NOTE:** At this time, the only light shining on the Display should be the green power light.

## Fat Extraction Calculations

### Crude Fat (Low Fat & Liquid Samples)

$$\text{Crude Fat (\%)} = \frac{(W_2 - W_3)}{W_1} * 100$$

- W<sub>1</sub> Original sample weight (g)
- W<sub>2</sub> Bag after initial drying (g)
- W<sub>3</sub> Bag after extraction and final drying (g)

### Crude Fat (High Fat Samples)

$$\text{Crude Fat (\%)} = \frac{(W_2 - W_4 - W_3)}{W_1} * 100$$

- W<sub>1</sub> Original sample weight (g)
- W<sub>2</sub> Bag and weigh tin after initial drying (g)
- W<sub>3</sub> Bag after extraction and final drying (g)
- W<sub>4</sub> Empty dry weigh tin (g)

### Total Fat

If hydrolysis is done prior to fat extraction, then the total fat contained within a food or feed sample can be calculated using the following formula:

$$\text{Total Fat (\%)} = \frac{(W_2 - (W_3 + (C_1 - C_2)))}{W_1} * 100$$

- W<sub>1</sub> Original sample weight (g)
- W<sub>2</sub> Bag after hydrolysis and drying (g)
- W<sub>3</sub> Bag after extraction and final drying (g)
- C<sub>1</sub> Blank bag weight, after hydrolysis and drying (g)
- C<sub>2</sub> Blank bag weight, after extraction and drying (g)

**NOTE:** The Hydrolysis procedure can be found in the ANKOM<sup>HCl</sup> Operator's Manual.

## Fat Extraction Support Items

The following support items are needed to perform the fat extraction procedure:

Item	Recommended Product
Filter Bags	ANKOM #XT4
Bag Weigh Holder (for adding sample to an empty filter bag)	ANKOM #101.2
Heat Sealer (for sealing the filter bags)	ANKOM #HS (120V), #HSi (220V)
Solvent Resistant Marker	ANKOM #F08
Desiccant Pouch or Weigh Tin Desiccator (for drying)	ANKOM #X45, #X49
Diatomaceous Earth (DE) (used with liquid samples)	ANKOM #DE1, DE2
Dryer (capable of temperatures from 60-120°C) - optional	ANKOM #RD (120V), #RDI (220V)
Electronic Balance with four-place readout	
Oven (capable of maintaining 102°C±2°) (for drying)	
Ventilated oven trays (for sufficient oven air flow)	
Weigh Tins (used with samples of > 20% fat)	
Sample	
Spoon	

## Sample Preparation

### Sample Preparation Procedure for Crude Fat – for **LOW fat samples**

To prepare meat samples with  $\leq 15\%$  fat by weight or plant samples with  $\leq 20\%$  fat by weight for fat extraction, follow the procedure detailed below.

The first step in crude fat analysis is drying the sample. If a sample is not dried, weight loss after extraction will be artificially high because it will include moisture loss.

1. Label/number all empty filter bags with a solvent resistant marker (SKU: #F08).



2. Place an empty filter bag in the Bag Holder in an open position. Record the weight of the empty bag ( $W_0$ ).

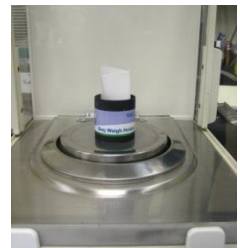

3. Tare the weight of the empty filter bag and the holder together.

4. Add 1.5 – 2g of sample to the filter bag. Keep all particles away from the sealing area of the filter bag.

5. Record the weight of the sample ( $W_1$ ) and tare.



6. Set the Heat Sealer dial to 6. (The setting may vary from sealer to sealer.)

7. Seal the filter bag within 4mm of its open end. Keep the sealer arm down for 2 – 3 seconds after the red sealer light turns off (to cool the seal). The seal can be seen as a solid melted stripe along the top edge of the filter bag (as shown to the right). If the seal is not strong, re-seal the bag.

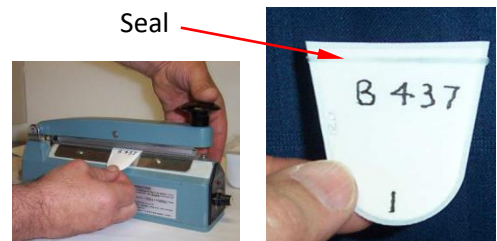

8. Repeat steps 1 – 7 for all filter bags that will be used in the ANKOM<sup>XT10</sup> Extraction System. (Up to 15 bags can be processed during one procedure.)

9. Dry all samples at  $102\text{ }^{\circ}\text{C} \pm 2\text{ }^{\circ}\text{C}$  for 3 hours to remove moisture.

10. Remove the samples from the oven and place them in a Desiccant Pouch.



11. Allow the samples to cool to room temperature. This should take about 10 – 15 minutes.

12. Weigh each bag immediately after removing from the Desiccant Pouch and record weight ( $W_2$ ).

The samples are now ready for the fat extraction procedure on the ANKOM<sup>XT10</sup> instrument.



**Sample Preparation Procedure for Crude Fat – for HIGH fat samples**

To prepare meat samples with > 15% fat by weight or plant samples with > 20% fat by weight for fat extraction, follow the procedure detailed below.

The first step in crude fat analysis is drying the sample. If a sample is not dried, weight loss after extraction will be artificially high because it will include moisture loss.

1. Label/number all weigh tins and empty filter bags with a solvent resistant marker (SKU: #F08). Use one weigh tin per filter bag.



2. Dry all weigh tins in an oven at  $102\text{ }^{\circ}\text{C} \pm 2\text{ }^{\circ}\text{C}$  for 15 minutes.

3. Remove weigh tins from the oven and place them in a Weigh Tin Desiccator or in a Desiccant Pouch.



4. Allow weigh tins to cool to room temperature.

5. Weigh and record tin weights ( $W_4$ ).



6. Place an empty filter bag in the Bag Holder in an open position. Record the weight of the empty bag ( $W_0$ ).

7. Tare the weight of the empty filter bag and the holder together.

8. Add 1.5 – 2g of sample to the filter bag. Keep all particles away from the sealing area of the filter bag.

9. Record the weight of the sample ( $W_1$ ) and tare.



10. Set the Heat Sealer dial to 6. (The setting may vary from sealer to sealer.)





11. Seal the filter bag within 4 mm of its open end. Keep the sealer arm down for 2 – 3 seconds after the red sealer light turns off (to cool the seal). The seal can be seen as a solid melted stripe along the top edge of the filter bag (as shown to the right). If the seal is not strong, re-seal the bag.

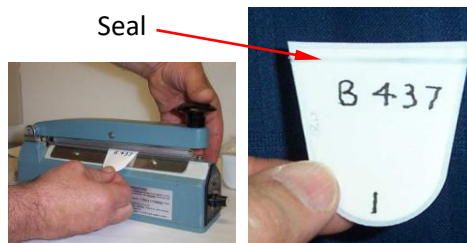

12. Repeat steps 1 – 11 for all filter bags that will be used in the ANKOM<sup>XT10</sup> Extraction System. (Up to 15 bags can be processed during one procedure.)

13. Place the sealed filter bags in their corresponding weigh tins for pre-drying.



14. Dry all samples at 102 °C ± 2 °C for 3 hours to remove moisture.

15. Remove the weigh tins and filter bags from the oven and place them together in a Weigh Tin Desiccator.



**NOTE:**

A Weigh Tin Desiccator is recommended because it will hold between 10 and 14 weigh tins with filter bags, depending on the size of the weigh tins. A Desiccant Pouch will hold about 4.

16. Allow the samples to cool to room temperature. This should take about 10 – 15 minutes.
17. Weigh and record the weights of each weigh tin ( $W_4$ ) and filter bag ( $W_2$ ) immediately after removing them from the Weigh Tin Desiccator.

The samples are now ready for the fat extraction procedure on the ANKOM<sup>XT10</sup> instrument.

### Sample Preparation Procedure for Crude Fat – for Liquid samples

To prepare liquid samples for fat extraction, follow the procedure detailed below.

The first step in crude fat analysis is drying the sample. If a sample is not dried, weight loss after extraction will be artificially high because it will include moisture loss.

1. Label/number all empty filter bags with a solvent resistant marker (SKU: #F08).

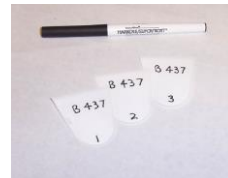

2. Place an empty filter bag in the Bag Holder in an open position. Record the weight of the empty bag ( $W_0$ ).

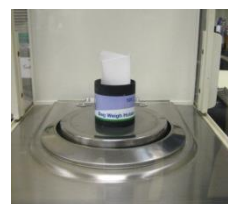

3. Tare the weight of the empty filter bag and the holder together.

4. Add 1.0 – 1.5g Diatomaceous Earth (DE) to the filter bag. Using a pencil eraser (or similar sized utensil), make an indentation in the DE that the sample will later be placed into. Record the weight of the DE ( $W_{DE}$ ) and then tare.



5. Pipette 1.5 – 2 g of liquid sample into the indentation in the DE. (Do NOT use more liquid sample than can be absorbed by the DE.)



6. Record the weight of the sample ( $W_1$ ).

7. Set the Heat Sealer dial to 6. (The setting may vary from sealer to sealer.)



8. Seal the filter bag within 4mm of its open end. Keep the sealer arm down for 2 – 3 seconds after the red sealer light turns off (to cool the seal). The seal can be seen as a solid melted stripe along the top edge of the filter bag (as shown to the right). If the seal is not strong, re-seal the bag.



Seal

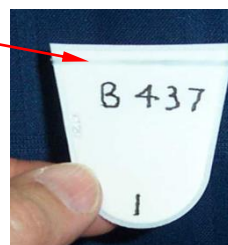

9. Repeat steps 1 – 8 for all filter bags that will be used in the ANKOM<sup>XT10</sup> Extraction System. (Up to 15 bags can be processed during one procedure.)

10. Dry all samples at 102 °C ± 2 °C for 3 hours to remove moisture prior to the extraction.
11. Remove the samples from the oven and place them in a Desiccant Pouch.
12. Allow the samples to cool to room temperature. This should take about 10 – 15 minutes.



13. Weigh and record the weights of each bag ( $W_2$ ) immediately after removing them from the Desiccant Pouch.

The samples are now ready for the fat extraction procedure on the ANKOM<sup>XT10</sup> instrument.

This page intentionally left blank

## Fat Extraction step-by-step procedure using the ANKOM<sup>XT10</sup>

To perform fat extraction on prepared samples, follow the procedure detailed below.

### 1. Turn the instrument power ON.

The Display will briefly show the software version number followed by the screen to the right.

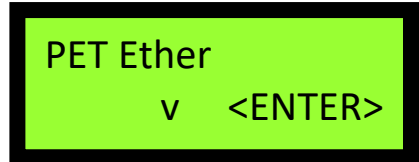

**NOTE:** The factory default solvent shown on the Display is "Pet Ether." However, the instrument will save the last solvent selection as the default solvent.

### 2. Select the solvent you want to use.

2.1 Press the Down Arrow (v) key on the Keypad until the desired solvent is shown on the Display.

**NOTE:** The recommended solvent for use in the ANKOM<sup>XT10</sup> Extraction System is Petroleum Ether with a boiling point range of 35°C to 65°C. If you want to use other solvents, you will need to install the XT O-ring kit for High Penetration Solvents (part # X95) and the Valve Kit for High Penetration Solvents (part # X73).



**Warning:** Do NOT use Acetone in this instrument because it will damage the valves.

2.2 Press ENTER on the Keypad to complete the solvent selection.

The Display should now show the screen to the right.

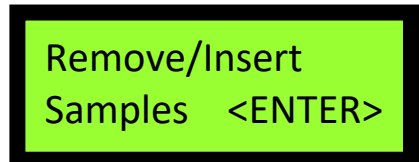

### 3. Insert Filter Bags into the PTFE Insert.

3.1 Press down the Safety Valve Handle to release the Safety Valve Pin and rotate the Main Handle upward until it stops.



3.2 Use the Extraction Vessel Handle to pull the Extraction Vessel out.



3.3 Remove the white PTFE Insert from the Extraction Vessel.

PTFE Insert

Bag Holder

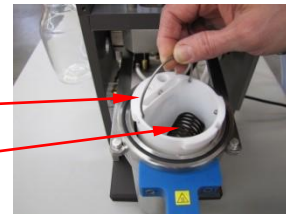

3.4 Remove the Bag Holder from the PTFE Insert.

3.5 Place up to 15 bags in the Bag Holder.

3.6 Place the Bag Holder in the PTFE Insert.

3.7 Press ENTER on the Keypad.

The Display should now show the screen to the right.

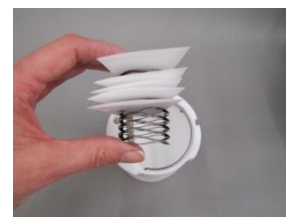

Select time 60  
(^v)... <ENTER>

#### 4. Set the Extraction Time.

4.1 Using the arrow keys on the Keypad, select the Extraction time. *(The recommended time is 60 minutes.)*

4.2 Press ENTER on the Keypad.

The Display should now show the screen to the right.

Select temp 90  
(^v)... <ENTER>

#### 5. Set the Extraction Temperature.

5.1 Using the arrow keys on the Keypad, select the Temperature. *(The recommended maximum temperature is 90°C.)*

5.2 Press ENTER on the Keypad.

The Display should now show the screen to the right.

Insert Solvent  
<ENTER>

#### 6. Insert solvent into the Extraction Vessel.

6.1 Ensure that the Extraction Vessel is cool.

6.2 Pour 350ml of solvent directly into the empty Extraction Vessel.



**7. Put the PTFE Insert into the Extraction Vessel and the Extraction Vessel into the instrument.**

7.1 Align the PTFE Insert slot with the Extraction Vessel pin.

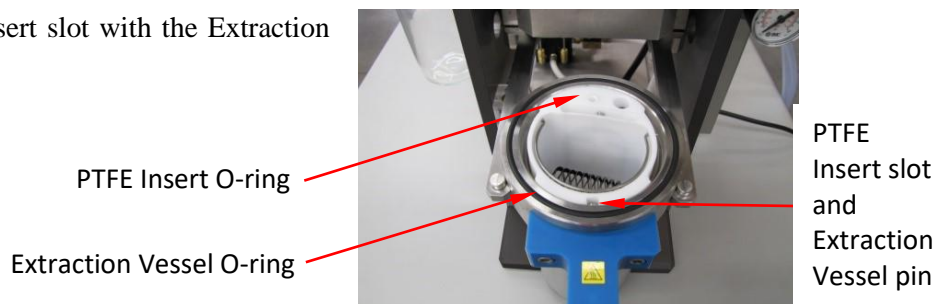

**IMPORTANT:**

- The PTFE Insert O-ring and the Extraction Vessel O-ring must be in place before running the instrument.
- The PTFE Insert slot must be aligned with the Extraction Vessel pin before running the instrument.

7.2 Slide the Extraction Vessel into the instrument ensuring the Extraction Vessel O-ring stays in place.

7.3 Press ENTER on the Keypad.

The Display should now show the screen to the right.

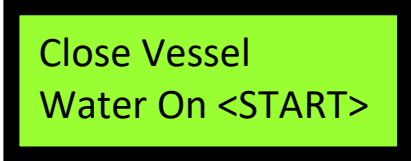

7.4 Pull the Main Handle downward, closing and locking the Extraction Vessel in place. You will hear a click noise when the Safety Valve Pin locks in place.



**IMPORTANT:** Before running the instrument, verify that the Extraction Vessel is locked in place by attempting to rotate the Main Handle upward. If it is not locked, repeat step 7.4 above.

7.5 Verify that the water supply is on.

**8. Run the instrument.**

Press START on the Keypad.

The instrument will run through its automatic operation, showing its status on the Display. When the instrument has completed its automatic operation, the Display will show the screen to the right (showing the solvent that was run last).

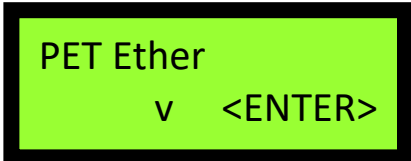

**NOTE:** At this time, the only light shining on the Display should be the green power light.

**9. Determine the amount of fat that was extracted.**

- 9.1 When the Pressure Gauge reads zero, remove the Extraction Vessel by pushing down on the Safety Valve Handle to release the locking pin and then rotating the Main Handle to the open position.
- 9.2 Use the Extraction Vessel Handle to remove the Extraction Vessel.



**Warning:** The Extraction Vessel interior and top will be **HOT** when the extraction process is complete.

- 9.3 Remove the PTFE Insert from the Extraction Vessel.
- 9.4 Remove the Bag Holder from the PTFE Insert.
- 9.5 Remove the filter bags from the Bag Holder.
- 9.6 Dry the samples for 15 – 30 minutes in the oven at  $102 \pm 2^\circ\text{C}$  or in the ANKOM<sup>RD</sup> Dryer set at the factory setting of  $110^\circ\text{C}$ .
- 9.7 Remove the samples from the oven or dryer and place them in a Desiccant Pouch.
- 9.8 Allow the samples to cool to room temperature. This should take about 10 – 15 minutes.
- 9.9 Weigh and record weight of each filter bag ( $W_3$ ) immediately after removing from the Desiccant Pouch.
- 9.10 Calculate crude or total fat content using ANKOM calculation spreadsheets or equations listed in this manual.

**10. Clean the fat from the bottom of the vessel using paper towels.**

**IMPORTANT:** If too much fat accumulates in the bottom of the Extraction Vessel, an “over temperature” fault will occur.



## Periodic Maintenance

### Cleaning the Extraction Vessel

Some compounds extracted during the fat extraction procedure can create a black residue in the bottom of the Extraction Vessel. The vessel can most easily be cleaned by using a drill with a long shafted stiff wire brush. This treatment will remove a lot of the black coating that accumulates on the bottom of the vessel. When the vessel bottom is clean, put some solvent on a cloth or paper towel and wipe down the inside of the vessel in an effort to remove any oil residue and particles that have been loosened from the vessel bottom.

**IMPORTANT:** Do not use soap and/or water to clean the vessel.

### Cleaning the exterior of the instrument

Wipe the outside of the instrument with window cleaner or a damp sponge as necessary.

**NOTE:** Do not use Acetone to clean the instrument.

### Cleaning the solvent filter

If filter bags are not sealed properly and sample is lost from the bag, it will be recovered in the solvent filter in the exhaust line.

To clean the solvent filter, follow the procedure detailed below.

1. Remove the rear cabinet of the instrument.
2. Unscrew the compression fitting.
3. Unscrew the filter body.
4. Unscrew and clean the metal filter screen.
5. Reassemble the filter and compression fitting. Make sure the valve body is tight and the PTFE washer has not come out of the filter body.

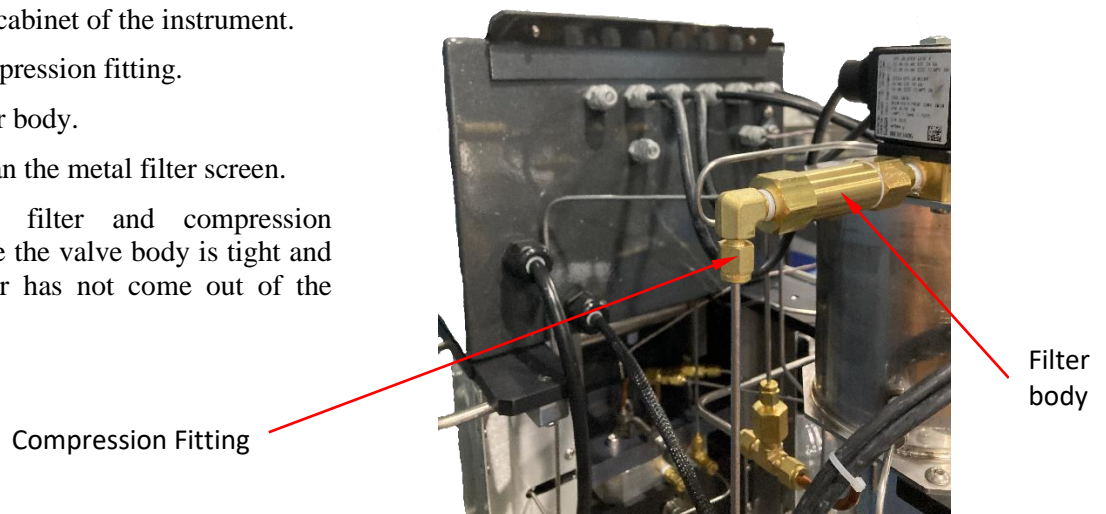

**Rear View of instrument with cabinet back removed**

### Cleaning the water filter

To clean the water filter (located on the water supply line), follow the procedure detailed below.

1. Unscrew the filter from the instrument.
2. Unscrew the filter clamp from the water supply line.
3. Use compressed air to blow backwards through the filter (blow opposite the arrow on the filter). If the filter is clogged, replace it with ANKOM part # X97.
4. Reconnect the filter and fittings.
5. Turn on the water and check for leaks.

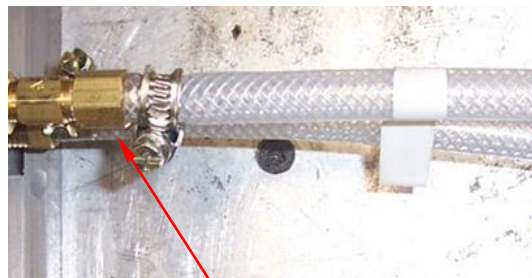

Filter

### Replacing the Fuses

To replace the fuses in the ANKOM<sup>XT10</sup> Extraction System, follow the procedure detailed below.

1. Turn off the instrument power and unplug the Power Cord from the outlet.
2. Remove the two screws on the Top Cover.
3. Swing the Top Cover down exposing the electrical compartment.
4. Locate the Fuse Holders on the terminal strip. There are two fuses within the instrument; one for each pole (100 – 120V 10A or 220 – 240V 5A).

Fuse Holders

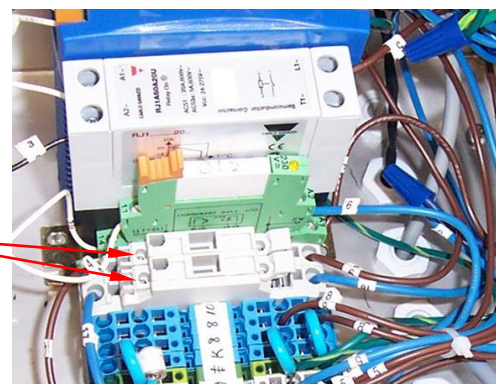

5. Press the tabs to lift the Fuse Holders up.

Tab to open Fuse Holder

Fuse

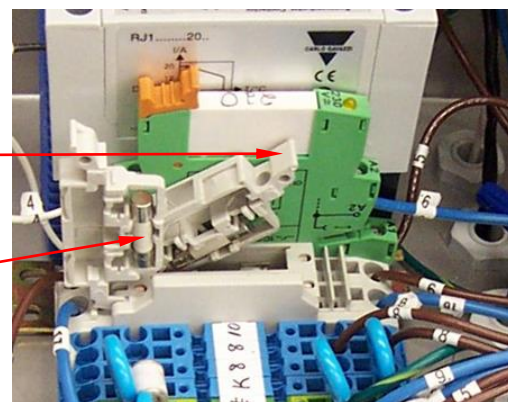

6. Replace the fuses and close the Fuse Holders completely.
7. Close the Top Cover and secure it with the two screws that you previously removed.

## Troubleshooting & Replacement Parts

The ANKOM technology web site has the most current troubleshooting and replacement parts information. Therefore, if you have any questions about the operation of your ANKOM<sup>XT10</sup> Extraction System, or if you need replacement parts, please visit our web site at [www.ankom.com](http://www.ankom.com).

This page intentionally left blank

## Diagnostics

To help solve problems that may occur while running the ANKOM<sup>XT10</sup> Extractor, the following computer-controlled Diagnostics are available and accessible through the Display and Keypad.

1. Toggle Outputs (Heater Relay Q0, and valves Q1, Q2, Q3, Q5 and Q6)
2. Check Temperature Sensor
3. Check the state of the ETS (Emergency Temperature Shut-off switch) relay

### Access Diagnostics Screen

When the instrument is powered up or when the instrument finishes a run, the screen to the right is displayed.

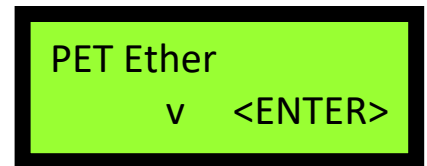

**NOTE:** The factory default solvent shown on the Display is "Pet Ether." However, the instrument will save the last solvent selection as the default solvent.

To access the Diagnostics Screen, press the Down Arrow button (v) on the Keypad four times. The screen to the right will be displayed. From the Diagnostics Screen you can access all of the available diagnostics.

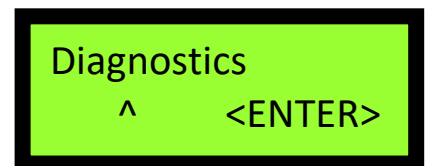

### Toggle Outputs

To toggle outputs, follow the procedure below.

1. With the Diagnostics screen displayed, press the ENTER button on the Keypad. The screen to the right will be displayed.

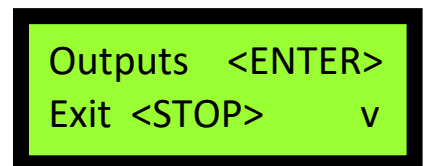

**NOTE:** If you press the STOP button on the Keypad while this screen is displayed, you will go back to the Diagnostics screen. If you press the Down Arrow button (v) on the Keypad while this screen is displayed you will go to the next group of diagnostics (Analog).

2. With the Outputs screen displayed, press the ENTER button on the Keypad. The screen to the right will be displayed.

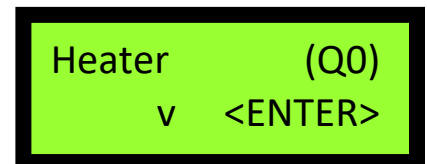

3. Press the Down Arrow button (v) on the Keypad to select the heater relay (Q0) or valves (Q1, Q2, Q3, Q5, and Q6) you want to toggle. With your selection made (in this example we selected the heater relay Q0), press the ENTER button on the Keypad. The screen to the right will be displayed.

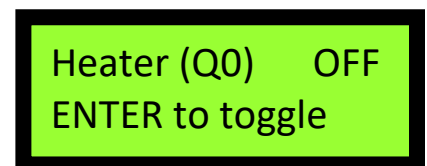

4. Press the ENTER button on the Keypad to turn ON the heater relay (Q0). The screen to the right will be displayed.

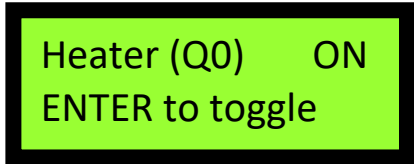

5. Press the ENTER button on the Keypad to turn OFF the heater relay (Q0). The screen to the right will be displayed.

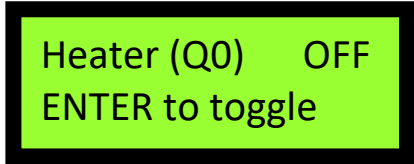



**Warning:** If the heater relay (Q0) is left ON, the Extraction Vessel interior will become very **HOT** and within five minutes the instrument ETS switch will trip followed by a six minute cool-down. The following Fault screen will be displayed after the cool-down is complete.

Diagnostics      ETS  
Fault      <ENTER>

From this screen press ENTER to get back to the main Diagnostics screen.

6. Press the STOP button on the Keypad to go back to the main Outputs screen (shown to the right).

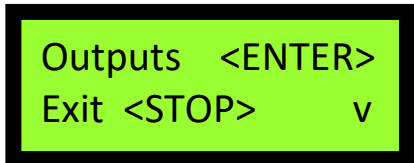

7. Press the STOP button on the Keypad to go back to the main Diagnostics screen (shown to the right).

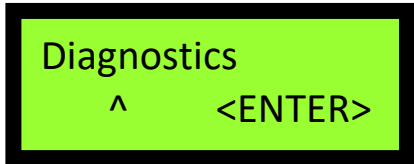

8. Press the Up Arrow button (^) on the Keypad to exit Diagnostics. Press the Up Arrow button (^) on the Keypad up to three more times to return to your solvent screen (example shown to the right).

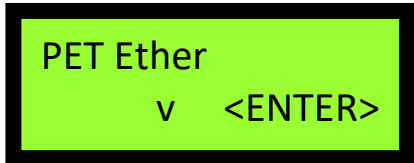

**NOTE:** When you exit Diagnostics, heater relay Q0 turns OFF and valves Q1, Q2, Q3, Q5, and Q6 return to the closed position.

## Check Temperature Sensor

To check the Temperature Sensor, follow the procedure below.

1. Access the Diagnostics screen (see "Access Diagnostics Screen" section for details).

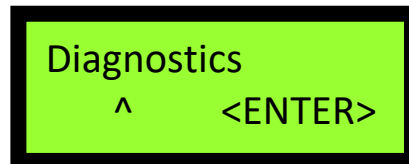

2. With the Diagnostics screen displayed, press the ENTER button on the Keypad. The screen to the right will be displayed.

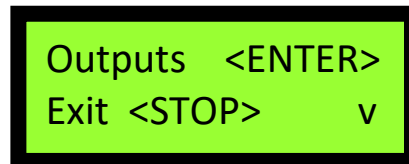

3. Press the Down Arrow button (v) on the Keypad. The screen to the right will be displayed.

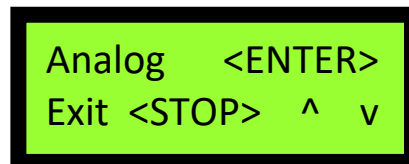

4. Press the ENTER button on the Keypad. The screen to the right will be displayed showing the current Temperature Sensor reading.

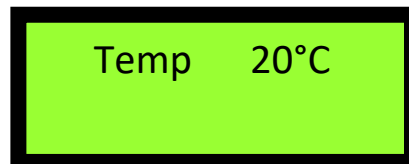

When the instrument has not been run for more than two hours, the temperature should read the ambient temperature of the room. If the temperature reading does not show ambient temperature when the instrument is cool, contact ANKOM Technology.

5. Press the STOP button on the Keypad to go back to the Analog screen (shown to the right).

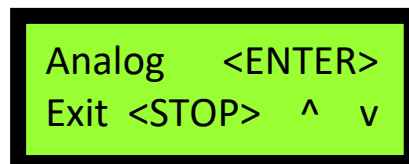

6. Press the STOP button on the Keypad to go back to the main Diagnostics screen (shown to the right).

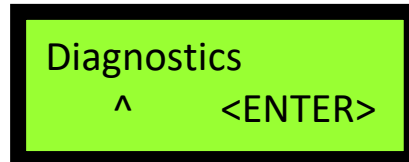

7. Press the Up Arrow button (^) on the Keypad to exit Diagnostics. Press the Up Arrow button (^) on the Keypad up to three more times to return to your solvent screen (example shown to the right).

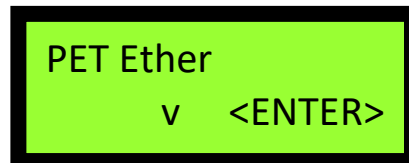

**Check the state of the ETS (Emergency Temperature Shut-off switch) relay**

To check the state of the ETS relay, follow the procedure below.

1. Access the Diagnostics screen (see "Access Diagnostics Screen" section for details).
2. With the Diagnostics screen displayed, press the ENTER button on the Keypad. The screen to the right will be displayed.
3. Press the Down Arrow button (v) on the Keypad. The screen to the right will be displayed.
4. Press the Down Arrow button (v) on the Keypad. The screen to the right will be displayed.
5. Press the ENTER button on the Keypad. The screen to the right will be displayed showing the state of the ETS relay. If the ETS relay is "OFF", contact ANKOM Technology.
6. Press the STOP button on the Keypad to go back to the Inputs screen (shown to the right).
7. Press the STOP button on the Keypad to go back to the main Diagnostics screen (shown to the right).
8. Press the Up Arrow button (^) on the Keypad to exit Diagnostics. Press the Up Arrow button (^) on the Keypad up to three more times to return to your solvent screen (example shown to the right).

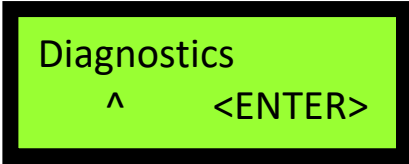

```
Diagnostics
^ <ENTER>
```



```
Outputs <ENTER>
Exit <STOP> v
```



```
Analog <ENTER>
Exit <STOP> ^ v
```



```
Inputs <ENTER>
Exit <STOP> ^
```

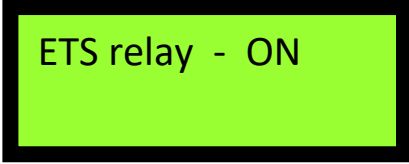

```
ETS relay - ON
```



```
Inputs <ENTER>
Exit <STOP> ^
```

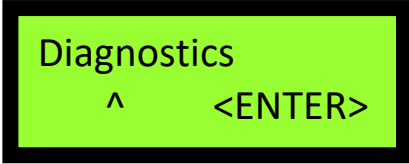

```
Diagnostics
^ <ENTER>
```

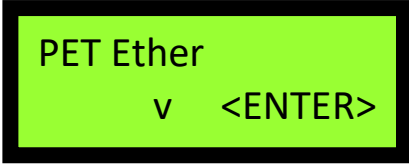

```
PET Ether
v <ENTER>
```



## Appendix A - Analytical Procedures

**IMPORTANT:** While infrequent, procedures may be updated with new information. For the most up-to-date procedure revision refer to: <https://www.ankom.com/analytical-methods-support/ankom-xt10-extractor>.

### I. Rapid Determination of Oil/Fat Utilizing High Temperature Solvent Extraction

*Analytical procedure- XT10/XT10i/XT15/XT15i*

#### Definition

This method determines crude fat by extraction with petroleum ether or other common fat solvents. The compounds extracted are predominantly triacylglycerides along with small amounts of other lipids.

#### Scope

This method is applicable to solid processed foods with 0-100% fat content.

#### Abstract

AOCS AM 5-04 is used for the determination of crude fat in grains, cereals, meats, pet foods, mixed feeds, forages, oilseeds and other processed foods. The process uses the Soxhlet principle in a closed stainless steel extraction vessel allowing solvent temperatures to exceed solvent boiling points. This improves the kinetics and reduces extraction times. Up to 15 samples are encapsulated in XT4 filter bags and placed in a specially designed siphoning carrier that is secured in the extraction vessel. The instrument will automatically perform all of the necessary procedural steps to complete the extraction and recycle the solvent, ready for reuse. Extracted samples are dried for approximately 30 minutes, reweighed and fat content determined by loss of weight.

Complete operational details are available in the ANKOM User Manuals.

AOCS Am 5-04 can be obtained directly from [AOCS](#).

## II. Oilseed Extractions (FOSFA comparable)

*Analytical procedure- XT10/XT10i/XT15/XT15i*

**The technique is used for the extraction of oilseeds:**

1. Place 1.5 to 2.0 g of sample into the XT4 Filter Bag.
2. Dry the samples for three hours at 100° - 105° C.
3. Remove the samples from the oven and place them in a desiccant pouch, allow them to cool and record their weights.
4. Extract the samples in an ANKOM XT instrument for forty minutes.
5. Dry the samples for thirty minutes at 100° - 105° C.
6. Remove the samples from the oven and place them in a desiccant pouch, allow them to cool, and record their weights.
7. Place one XT4 Filter Bag (with sample) into a mortar and strike it with a pestle approximately 15-20 times being careful not to twist the pestle. There does not need to be a great deal of force when the pestle strikes the Filter Bag. Repeat for all Filter Bags.
8. Repeat steps 4-7 two more times (for a total of three times).
9. Add the three fat values together to get a combined fat total.

## III. Mojonnier Method

The XT10 instrument can run an extraction similar to ISO 1735 (Mojonnier method). The solvent mixture used is 45% (v/v) petroleum ether, 45% (v/v) diethyl ether and 10% (v/v) ethanol.

## Appendix B – Electrical Diagram (pg. 1 of 3)

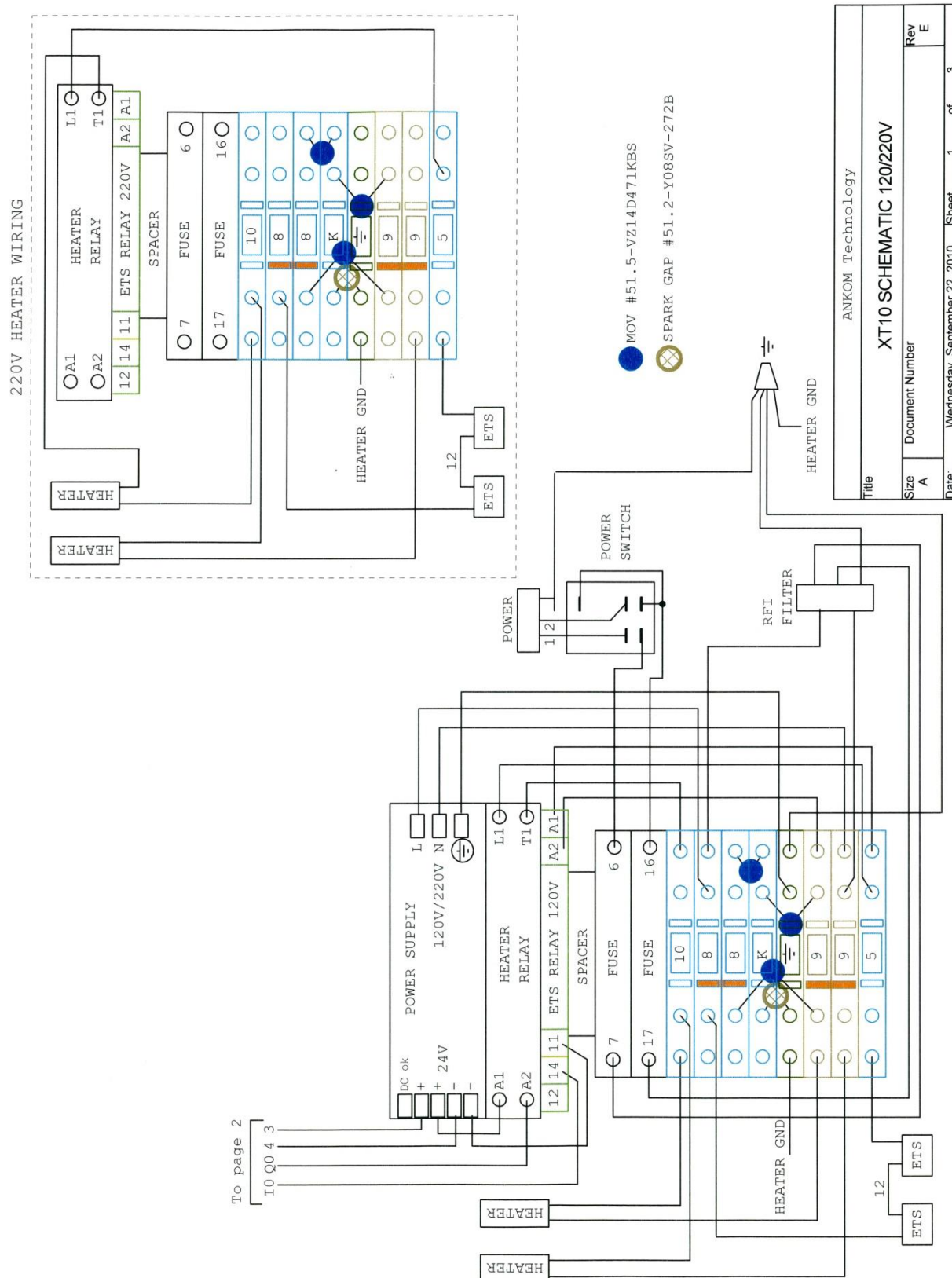

ANKOM Technology	
Title <b>XT10 SCHEMATIC 120/220V</b>	
Size A	Document Number
Date: Wednesday, September 22, 2010	Sheet 1 of 3
Rev E	

## Appendix A – Electrical Diagram (pg. 2 of 3)

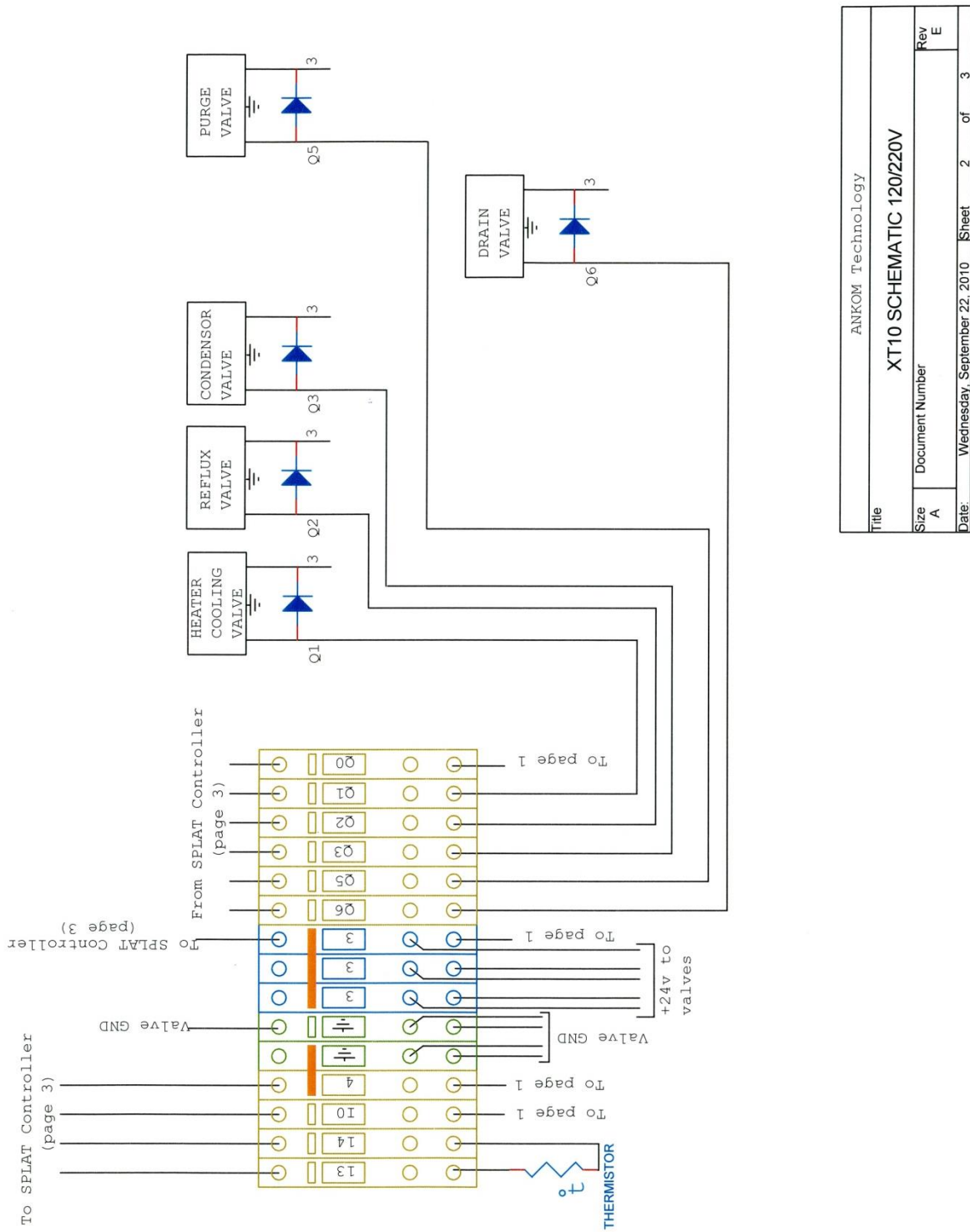

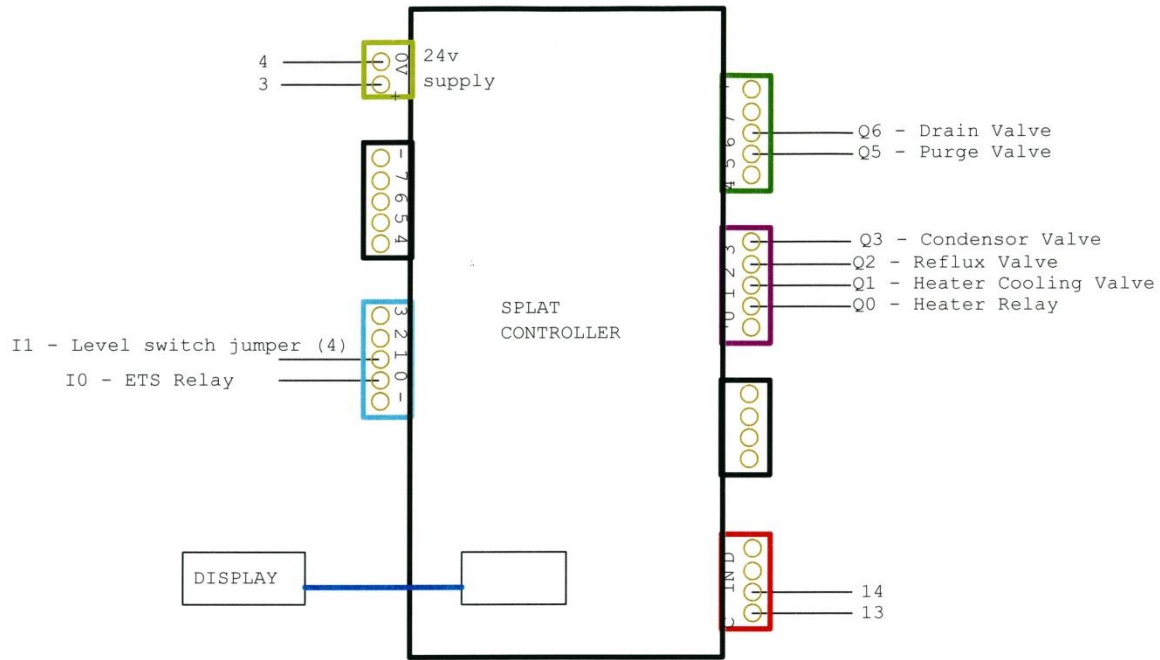

## Appendix A – Electrical Diagram (pg. 3 of 3)



ANKOM Technology		
Title XT10 SCHEMATIC 120/220V		
Size	Document Number	Rev E
Date: Wednesday, September 22, 2010 Sheet 3 of 3		

# Automation saves time and money!

ANKOM Technology is an international company with products that include...

	<p><b>FLEX Analyte Extractor</b></p> <ul style="list-style-type: none"> <li>• Simplifies fat-soluble vitamin and cholesterol analysis</li> <li>• Crude and total fat analysis capability coming soon</li> <li>• Eliminates chemical handling to improve safety</li> <li>• Eliminates bi-phase extractions</li> <li>• Provides ability to create custom methods</li> </ul>
	<p><b>TDF Dietary Fiber Analyzer</b></p> <ul style="list-style-type: none"> <li>• Automates AOAC 991.43/AACC 32.07.01</li> <li>• IDF/SDF and TDF values</li> <li>• Faster, Technician-free Filtering</li> <li>• Computer controlled operation</li> <li>• Reduced per assay costs</li> </ul>
	<p><b>DELTA Automated Fiber Analyzer with Pump System</b></p> <ul style="list-style-type: none"> <li>• Crude Fiber (AOCS Ba 6a-05), ADF, NDF determinations</li> <li>• Automatically adds solutions and rinses</li> <li>• Batch process - up to 24 samples at one time</li> </ul>
	<p><b>XT15 Fat Extractor</b></p> <ul style="list-style-type: none"> <li>• Official Method AOCS Am 5-04</li> <li>• Fully automatic</li> <li>• Solvent recovery at 97% or greater</li> <li>• Batch process - up to 15 samples at one time</li> </ul>
	<p><b>RF Gas Production System</b></p> <ul style="list-style-type: none"> <li>• High sensitivity pressure measurement</li> <li>• Applications include: Ruminant Nutrition, Human Digestion, Yeast Activity, Beer/Wine Fermentation, Biomass-to-Energy analysis (e.g., Ethanol), Biodegradability, Soil respiration, BOD, etc.</li> <li>• Wireless Computer control and data storage</li> </ul>

Please visit our web site at [www.ankom.com](http://www.ankom.com) for more information.

2052 O'Neil Rd, Macedon NY 14502  
 Telephone: (315) 986-8090  
 Fax: (315) 986-8091  
[www.ankom.com](http://www.ankom.com)

